

SMART Board® 8070i-SMP and 8070i

Interactive flat panels

User's guide

Product registration

If you register your SMART product, we'll notify you of new features and software upgrades.

Register online at smarttech.com/registration.

Keep the following information available in case you need to contact SMART Support.

Serial number:

Date of purchase:

FCC warning

This equipment has been tested and found to comply with the limits for a Class A digital device, pursuant to Part 15 of the FCC Rules. These limits are designed to provide reasonable protection against harmful interference when the equipment is operated in a commercial environment. This equipment generates, uses and can radiate radio frequency energy and, if not installed and used in accordance with the manufacturer's instructions, may cause harmful interference to radio communications. Operation of this equipment in a residential area is likely to cause harmful interference in which case the user will be required to correct the interference at his own expense.

Trademark notice

SMART Board, SMART Ink, SMART Notebook, SMART Meeting Pro, DVIT, SMART GoWire, smarttech, the SMART logo and all SMART taglines are trademarks or registered trademarks of SMART Technologies ULC in the U.S. and/or other countries. Mac and Mac OS X are trademarks of Apple Inc., registered in the U.S. and other countries. Windows is either a registered trademark or a trademark of Microsoft Corporation in the U.S. and/or other countries. HDMI is a trademark or registered trademark of HDMI Licensing LLC. All other third-party product and company names may be trademarks of their respective owners.

Copyright notice

© 2011–2012 SMART Technologies ULC. All rights reserved. No part of this publication may be reproduced, transmitted, transcribed, stored in a retrieval system or translated into any language in any form by any means without the prior written consent of SMART Technologies ULC. Information in this manual is subject to change without notice and does not represent a commitment on the part of SMART.

Patent No. US6320597; US6326954; US6563491; US6741267; US6803906; US6829372; US6947032; US6954197; US6972401; US7151533; US7236162; US7411575; US7619617; US7643006; US7692625; US7755613; US7757001; US7880720; USD612396; USD616462; USD617332; and USD636784.

09/2012

Important information for your interactive flat panel

WARNING

- Failure to follow the installation instructions shipped with your SMART product could result in personal injury and product damage which may not be covered by your warranty.
- Do not open or disassemble the SMART product. You risk electrical shock from the high voltage inside the casing. Opening the casing also voids your warranty.
- Do not stand (or allow children to stand) on a chair to touch the surface of your SMART product. Rather, mount the product at the appropriate height.
- To reduce the risk of fire or electric shock, do not expose the SMART product to rain or moisture.
- If your SMART product requires replacement parts, make sure the service technician uses replacement parts specified by SMART Technologies or parts with the same characteristics as the original.
- Ensure that any cables extending across the floor to your SMART product are properly bundled and marked to avoid a trip hazard.
- Do not insert objects inside the cabinet ventilation holes, because they could touch dangerous voltage points and cause electric shock, fire or product damage which may not be covered by your warranty.
- Do not place any heavy objects on the power cable. Damage to the cable could cause shock, fire or product damage which may not be covered by your warranty.
- Use only extension cords and outlets into which this product's polarized plug can be fully inserted.
- Use the power cable provided with this product. If a power cable is not supplied with this product, please contact your supplier. Use only power cables that match the AC voltage of the power outlet and that comply with your country's safety standards.
- If the glass is broken, do not touch the liquid crystal. To prevent injury, handle glass fragments with care when disposing of them.

IMPORTANT INFORMATION FOR YOUR INTERACTIVE FLAT PANEL

- Do not move or mount the interactive flat panel by connecting rope or wire to its handles. Because the interactive flat panel is heavy, rope, wire or handle failure could lead to personal injury.
- To prevent personal injury, do not attempt to mount or carry the interactive flat panel using your own strength. Instead, use a lifting device with the included M12 attachable eyebolts. The eyebolts are not post-installation hardware.
- Use only VESA®-approved mounting hardware.
- Lamps in this product contain mercury. Handle lamps with care. Comply with local, state or federal law when recycling or disposing of lamps from this product.
- Disconnect all power cables for your interactive flat panel from the wall outlet and seek assistance from qualified service personnel when any of the following occurs:
 - The power cable or plug is damaged
 - Liquid is spilled into the interactive flat panel
 - Objects fall into the interactive flat panel
 - The interactive flat panel is dropped
 - Structural damage such as cracking occurs
 - The interactive flat panel behaves unexpectedly when you follow operating instructions

CAUTION

- Before you clean your SMART product, shut down or disconnect the computer. Otherwise, you may scramble the desktop icons or inadvertently activate applications when you wipe the screen.
- Avoid setting up and using the SMART product in an area with excessive levels of dust, humidity and smoke.
- Make sure an electrical socket is near your SMART product and remains easily accessible during use.
- The external power supply needs to meet the Limited Power Source (LPS) requirements of CSA/UL/IEC/EN 60950-1, when required.

IMPORTANT INFORMATION FOR YOUR INTERACTIVE FLAT PANEL

- This SMART product should be used only with European TN and TT power distribution systems.

It is not suitable for older, IT-type power distribution systems found in some European countries. "This system (IT-type) is widely used isolated from earth, in some installations in France, with impedance to earth, at 230/400V, and in Norway, with voltage limiter, neutral not distributed, at 230V line-to-line." (IEC 60950:1999)

Contact qualified personnel if you're uncertain of the type of power system available where you're installing your SMART product.

- You must connect the USB cable that came with your SMART Board® interactive flat panel to a computer that has a USB compliant interface and that bears the USB logo. In addition, the USB source computer must be compliant with CSA/UL/EN 60950 and bear the CE mark and CSA and/or UL Mark(s) for CSA/UL 60950. This is for operating safety and to avoid damage to the SMART Board interactive flat panel.

Contents

Important information for your interactive flat panel	i
Chapter 1: About your interactive flat panel	1
Feature highlights	2
Interactive flat panel components	3
Chapter 2: Installing your interactive flat panel	11
Environmental requirements	11
Wall-mounting your interactive flat panel	12
Chapter 3: Connecting computers and peripheral devices	15
Installing the speakers	16
Connecting a room control system	17
Connecting computers to your interactive flat panel	18
Connecting to power and your room computer	19
Installing a guest laptop connection	20
Disabling the USB receptacle on the side terminal panel	22
Connecting peripheral devices to your interactive flat panel	23
Chapter 4: Installing SMART software	25
Installing SMART Meeting Pro software	26
Installing SMART Notebook software	26
Chapter 5: Using your interactive flat panel	29
Turning on and turning off your interactive flat panel	30
Using the infrared remote control	31
Getting started with your SMART Board interactive flat panel	35
Playing audio files on your interactive flat panel	46
Using the USB receptacle	47
Chapter 6: Using guest laptops with your interactive flat panel	49
Connecting a guest laptop	49
Using a SMART GoWire cable	50
Connecting a side laptop	51
Chapter 7: Maintaining your interactive flat panel	53
Updating your SMART software and firmware	53
Calibrating your interactive flat panel	56
Orienting your interactive flat panel	57
Replacing a pen nib	57

CONTENTS

Cleaning the screen	58
Cleaning the camera windows and reflective tape	58
Maintaining ventilation	59
Preventing condensation	59
Checking the interactive flat panel installation	60
Removing your interactive flat panel	60
Transporting your interactive flat panel	61
Chapter 8: Troubleshooting for your interactive flat panel	63
Resolving image issues	63
Resolving touch control and digital ink issues	67
Resolving audio issues	70
Resolving remote control issues	71
Resolving issues using the SMART Connection Wizard	72
Resolving issues using SMART Board Diagnostics	73
Appendix A: Adjusting video settings with the on-screen display menu	75
Changing settings in the OSD menu	75
Main menu settings	76
Appendix B: Hardware environmental compliance	83
Waste Electrical and Electronic Equipment regulations (WEEE directive)	83
Restriction of Certain Hazardous Substances (RoHS directive)	83
Batteries	83
Packaging	84
China's Electronic Information Products regulations	84
Index	85

Chapter 1

About your interactive flat panel

Feature highlights	2
Commercial-grade, touch-enabled flat panel	2
Elegant, sophisticated design	2
Software	2
Dual sketch capabilities	2
SMART Ink™	2
Touch and gestures	3
Durable surface	3
Interactive flat panel components	3
Front view	3
LCD screen	3
Camera and reflective tape channel	3
Pen and eraser holders	4
Color select module	4
Front control panel	5
Infrared remote control	5
Left side view	6
Menu control panel	6
USB receptacle	6
Side terminal panel	6
Back view	7
Bottom terminal panel	8
Inside terminal panel	8
Audio terminal panel	9
Other components for the SMART Board 8070i-SMP interactive flat panel	9
SMART GoWire™ auto-launch cable	9
CAT 5 USB extender	9

CHAPTER 1

About your interactive flat panel

Feature highlights

Commercial-grade, touch-enabled flat panel

Your SMART Board 8070i interactive flat panel features SMART's proprietary DVIT® (Digital Vision Touch) technology on an LCD screen which enables you to select, write and erase on the interactive surface. It enables you to do everything you can do at your computer—open and close applications, conference with others, create new documents or edit existing ones, visit websites, play and manipulate video clips and more—just by touching the interactive surface. Two users can also draw on the interactive surface at the same time, and you can use an array of gestures within applications.

You can also write over any application in digital ink using a pen tray pen or your finger, and then save these notes for future reference and distribution.

Elegant, sophisticated design

The professional design and crisp, eye-catching visuals of the SMART Board 8070i interactive flat panel make it perfect for any high-end workspace.

Software

To use all the features of your interactive flat panel described in this guide, go to smarttech.com/downloads and ensure that you have the latest version of SMART software and SMART Product Drivers installed on your computer.

Dual sketch capabilities

Two people can each pick up a pen and draw on the interactive surface at the same time, providing a higher degree of interactivity.

SMART Ink™

SMART Ink enables you to write and draw in digital ink over open applications, files, folders, websites and any other open window on your computer. When you write outside the open windows on your computer, a SMART Ink Note appears and you can write inside the note.

When you open an application that has its own ink tools, you can turn off SMART Ink, and then use the application's ink tools to write in the content.

For more information, see the *SMART Ink user's guide for Windows® operating systems* (smarttech.com/kb/170191) or *SMART Ink user's guide for Mac OS X operating system software* (smarttech.com/kb/170192).

CHAPTER 1

About your interactive flat panel

Touch and gestures

You can perform mouse functions with your finger, and write and erase digital ink with a pen tray pen or the eraser. The object awareness feature enables you to pick up a pen, and then write, select or erase without replacing the pen.

Durable surface

The SMART Board 8070i interactive flat panel features a hardened glass screen.

Interactive flat panel components

Front view

The front of your interactive flat panel includes the LCD screen, the cameras and reflective tape channel, the pen holders with the pens, the eraser holder with an eraser and the color select module.

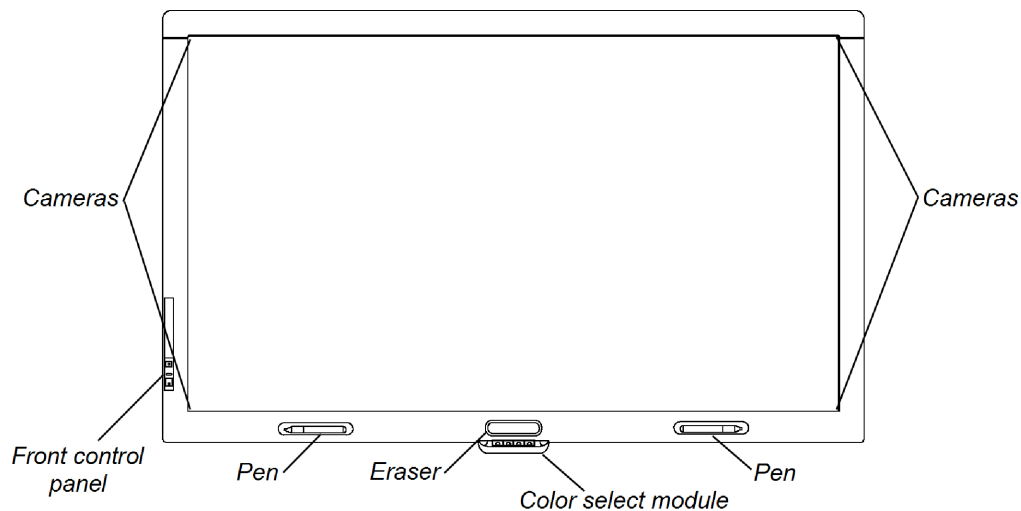

LCD screen

The screen is 61" W × 34 1/4" H (154.9 cm × 87.2 cm), with a 70" (178 cm) diagonal, 16:9 format.

For information on cleaning your LCD screen, see *Cleaning the screen* on page 58.

Camera and reflective tape channel

The interactive flat panel screen is bordered by a channel that contains reflective tape. Each corner has a camera that tracks finger and pen positions across the screen. For information on cleaning your camera windows and reflective tape, see *Cleaning the screen* on page 58.

CHAPTER 1

About your interactive flat panel

CAUTION

- Do not damage or remove the reflective tape.
- Keep the reflective tape dry.

IMPORTANT

- Do not attach items such as adhesive notes to the screen because they will interfere with the cameras.
- Do not place anything in the channel because it will interfere with the cameras.

Pen and eraser holders

The bottom bezel contains magnetic holders for two pens and an eraser. Removing a pen or the eraser from the holders activates it and enables you to either draw or erase digital ink.

CAUTION

When returning the pen or eraser to the magnetic holder, ensure that it is centered on the holder to prevent the pen or eraser from falling and potentially being damaged.

Color select module

The color select module enables you to access the help function, open the on-screen keyboard, select pen color, activate the right-click and orient the interactive flat panel.

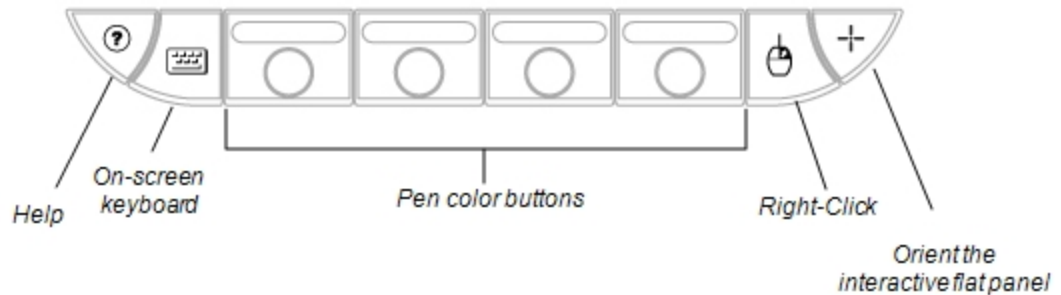

CHAPTER 1

About your interactive flat panel

Front control panel

The front control panel contains the volume control, mute, input and power buttons, as well as the status light and infrared remote control sensor.

IMPORTANT

Do not cover or block this area or you could have reduced use of the infrared remote control.

In normal use

- The volume, mute and input buttons are blue.
- The power button is green.
- The status light is green.

For information on diagnosing issues using the front control panel lights, see *Diagnosing blank screen issues using the front control panel lights* on page 63.

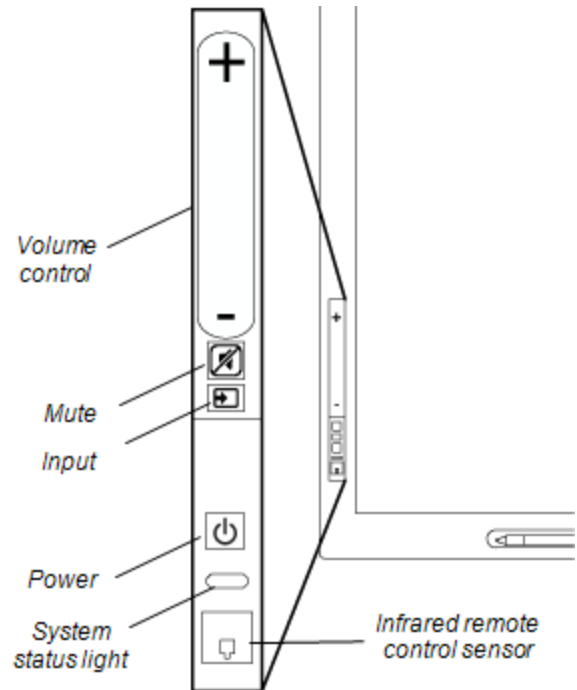

Infrared remote control

The infrared remote control enables you to turn on and turn off your interactive flat panel, change the input source, adjust the volume, access the on-screen menu and more. For more information on the infrared remote control, see *Using the infrared remote control* on page 31.

CHAPTER 1

About your interactive flat panel

Left side view

The left side of your interactive flat panel has the menu control panel and the side terminal panel.

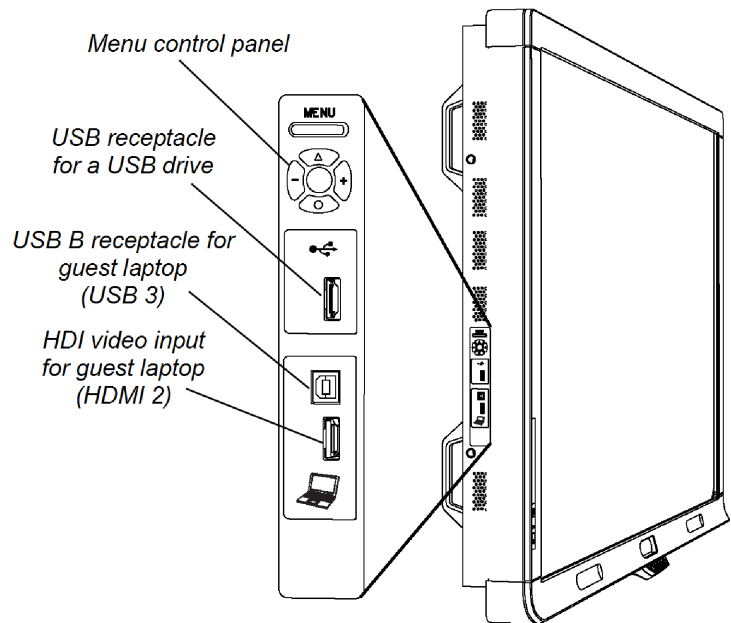

Menu control panel

The menu control panel enables you to access the on-screen display menu to adjust display and audio settings. For more information on the on-screen display menu, see *Adjusting video settings with the on-screen display menu* on page 75.

USB receptacle

The USB receptacle takes a USB type A connector, such as a USB memory drive. For more information on this receptacle, see *Using the USB receptacle* on page 47.

i NOTE

You can disable this USB receptacle so the room computer cannot access it. For instructions, see *Disabling the USB receptacle on the side terminal panel* on page 22.

Side terminal panel

The side terminal panel has USB and HDMI receptacles for connecting a side laptop. For more information on this terminal panel, see *Connecting a side laptop* on page 51.

CHAPTER 1

About your interactive flat panel

Back view

The back of the interactive flat panel includes the bottom terminal panel, the inside terminal panel and the audio connection terminal panel.

IMPORTANT

Connect all required cables before you wall-mount your interactive flat panel. Some connectors could be inaccessible after wall mounting.

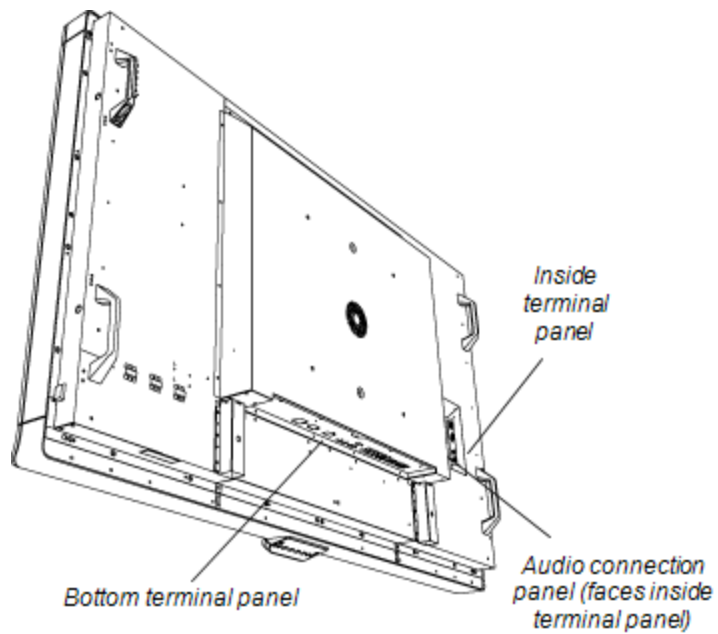

CHAPTER 1

About your interactive flat panel

Bottom terminal panel

The bottom terminal panel contains the main power switch and several connections, including both touch control connections and connections for auxiliary input and output devices, such as DVD players, Blu-ray™ players and VCRs.

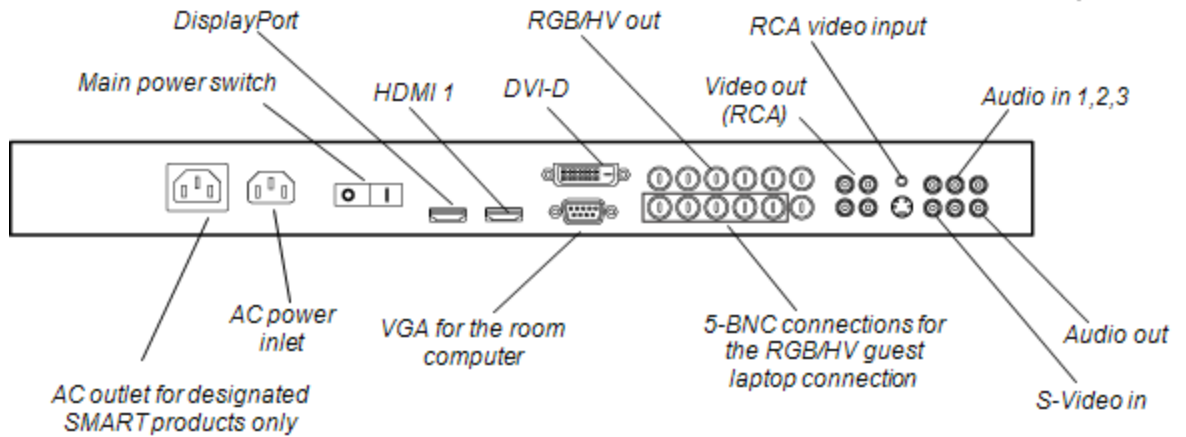

⚠ CAUTION

The AC power outlet is designated for a component of the SMART Board 8070ie-SMP interactive flat panel. Use this power outlet only as designated by documentation for that system. Using this power outlet for other items could damage the interactive flat panel.

Inside terminal panel

The inside terminal panel is on the left side of the interactive flat panel and contains the touch control USB connections and the room control input and output.

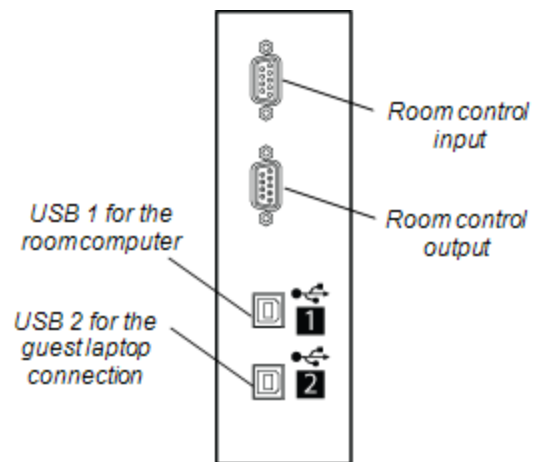

CHAPTER 1

About your interactive flat panel

Audio terminal panel

This panel contains the speaker wire connections and the wired remote control receptacles.

IMPORTANT

Do not connect RCA or 3.5 mm speaker plugs to the wired remote control receptacles. The infrared remote control is disabled while anything is inserted in these receptacles.

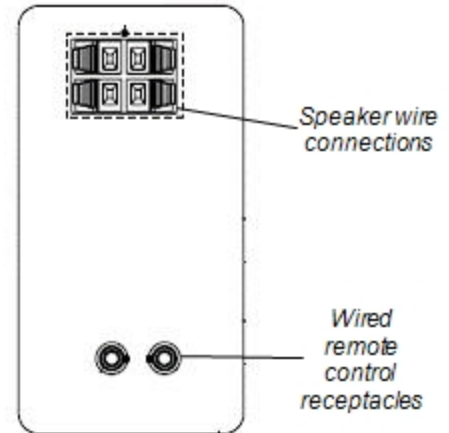

Other components for the SMART Board 8070i-SMP interactive flat panel

The following components are included with the SMART Board 8070i-SMP interactive flat panel.

SMART GoWire™ auto-launch cable

Enables you to use SMART Product Drivers and SMART Meeting Pro™ software without installing them on your computer. For more information, see *Using a SMART GoWire cable* on page 50.

CAT 5 USB extender

Extends a USB connection between your computer and the interactive flat panel. For more information, see the documentation included with the CAT 5 USB extender.

Chapter 2

Installing your interactive flat panel

Environmental requirements	11
Wall-mounting your interactive flat panel	12
Important mounting considerations for trained installers	13
Choosing a mounting location	13
Choosing a mounting height	14

You require a team of professional installers equipped with a lifting device to install your SMART Board 8070i interactive flat panel.

This chapter provides additional considerations and details for installing your interactive flat panel.

IMPORTANT

Because the receptacles might not be accessible after wall-installation, consider connecting cables for speakers, computers and peripheral devices while the interactive flat panel is still in its packaging or is suspended from a lifting device. For more information, see *Connecting computers and peripheral devices* on page 15.

Environmental requirements

Before installing your interactive flat panel, review the following environmental requirements. For more detailed information, see *SMART Board 8070i and 8070i-SMP interactive flat panel specifications* (smarttech.com/kb/155318) or *SMART Board 8070ie-SMP interactive flat panel with appliance specifications* (smarttech.com/kb/170078).

Environmental requirement	Parameter
Power requirements	.2A–3.7A at 100V–240V AC, 50 Hz–60 Hz
Power consumption at 77°F (25°C)	Typically up–530 W (brightness at 70% and volume at 40), maximum 580 W (brightness and volume at maximums)

CHAPTER 2

Installing your interactive flat panel

Environmental requirement	Parameter
Operating temperature	41°F–95°F (5°C–35°C)
Storage temperature	-4°F–140°F (-20°C–60°C)
Humidity	5%–80% relative humidity, non-condensing
Ventilation	Maintain a 4" (10 cm) ventilation area around your interactive flat panel to enable its cooling fans to operate. Do not store or operate your interactive flat panel in dusty environments because dust could interfere with the product's ventilation and cooling.
Water and fluid resistance	<ul style="list-style-type: none">• Intended for indoor use only. Doesn't meet any salt-spray or water ingress requirements.• Don't pour or spray liquids directly onto the interactive flat panel or any of its sub-components. These liquids might get into areas where they could damage sensitive electronic components. Refer to page 58 for detailed instructions on cleaning your interactive flat panel.

Wall-mounting your interactive flat panel

Use a team of trained, professional installers equipped with a lifting device to install your interactive flat panel.

WARNING

- Improper installation can result in personal injury or product damage.
- Your interactive flat panel weighs 262 lb. (119 kg). Refer to local building codes to ensure your installation area can support this weight.

CAUTION

Do not allow the weight of the interactive flat panel to rest on the color select module because it is not designed to support product weight. Attach other components while the interactive flat panel is either still in its packaging or suspended from a lifting device to prevent the weight of the interactive flat panel from damaging the color select module.

IMPORTANT

Save all product packaging so that it is available if you need to transport your interactive flat panel. If your original packaging is not available, you can purchase new product packaging from your authorized SMART reseller (smarttech.com/where).

CHAPTER 2

Installing your interactive flat panel

Important mounting considerations for trained installers

Consider the following when mounting the interactive flat panel on a wall:

- Attach the included M12 eyebolts and washers to assist in mounting, and remove them after you wall-mount the interactive flat panel.

WARNING

Do not attempt to mount or carry the interactive flat panel using your own strength because it could fall and cause personal injury. Attach a lifting device to the included M12 eyebolts to lift and carry the interactive flat panel.

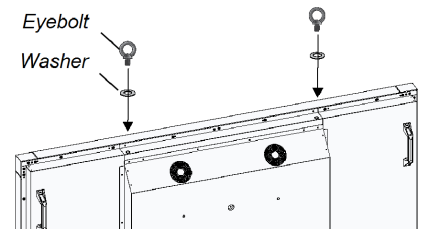

CAUTION

Hand-tighten the M12 eyebolts. If you over-tighten the eyebolts and damage the threads, you will be unable to remove the eyebolts.

- Plan your workflow to include cabling because some cable connection points might not be accessible after installation.

IMPORTANT

Attach the speakers and connect the speaker wires to the interactive flat panel before you wall-mount it. For more information, see *Installing the speakers* on page 16.

- To mount the interactive flat panel on a wall, you require a standard VESA 400 mm × 400 mm mounting plate (not included).
- Use M8 screws to fasten the wall bracket. The screws must be 14–15 mm long plus the thickness of the bracket and the washer.
- The recommended fasten force is 99.57–121.70 in-lb. (11.25–13.75 N·m).
- Refer to the instructions included with the mounting equipment for more detailed information.

Choosing a mounting location

Consider the following when you select a location for the interactive flat panel:

- The wall must be strong enough to support the interactive flat panel and the mounting equipment. The interactive flat panel weighs 262 lb. (119 kg).
- Do not install the interactive flat panel in a location where a door or gate could hit it.
- Do not install the interactive flat panel in an area where it will be subjected to strong vibrations or dust.

CHAPTER 2

Installing your interactive flat panel

- Do not install the interactive flat panel near where the main power supply enters the building.
- Ensure adequate ventilation or provide air conditioning around the interactive flat panel so that heat can flow away from the unit and the mounting equipment.
- If you mount the interactive flat panel in a recessed area, leave at least 4" (10 cm) of space between the interactive flat panel and the recess walls to enable ventilation and cooling.

Choosing a mounting height

Consider the general height of your user community when you choose the mounting height for the interactive flat panel.

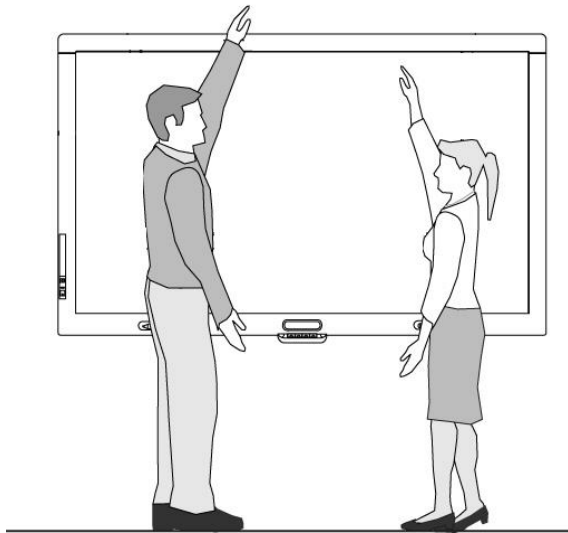

Chapter 3

Connecting computers and peripheral devices

Installing the speakers	16
Connecting a room control system	17
Connecting computers to your interactive flat panel	18
Interactive flat panel touch control and video input connections	18
Connecting to power and your room computer	19
Room computer connection diagram	19
Installing a guest laptop connection	20
Guest laptop connection diagram	21
Disabling the USB receptacle on the side terminal panel	22
Connecting peripheral devices to your interactive flat panel	23
Bottom terminal panel	23

This chapter includes information on connecting your interactive flat panel to computers and other peripheral devices.

IMPORTANT

Because the cable connection points might not be accessible after wall-installation, consider connecting these devices while the interactive flat panel is suspended from the lifting device.

Installing the speakers

Your interactive flat panel comes with two 15 W speakers.

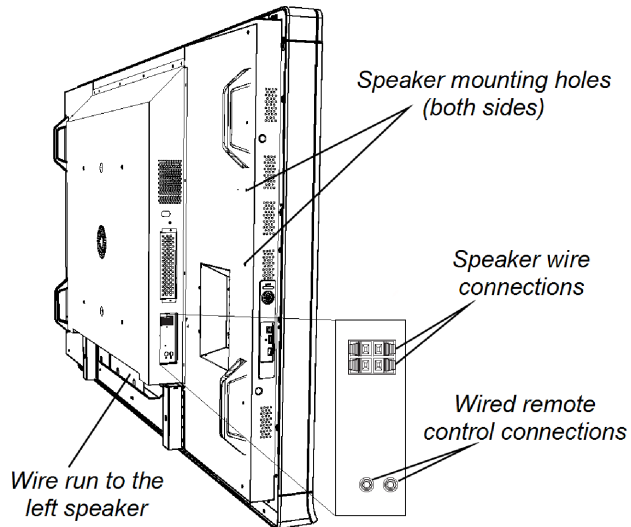

■ To install the speakers

1. Attach the speakers to the speaker mounting holes on the side of the interactive flat panel with the included screws.
2. Connect the speaker wires to the speaker wire connections.

IMPORTANT

Do not connect the speakers to the wired remote control 3.5 mm jacks. These are not audio connections. The remote control is disabled while anything is inserted into these jacks.

3. Run the speaker wire for the left speaker (when viewed from the back of the interactive flat panel) below the bottom terminal panel and secure it with the included small clamps.

Connecting a room control system

You can control your interactive flat panel from a room control system.

■ To connect your interactive flat panel to a room control system

Connect an RS-232 cable from the room control input on the inside terminal panel of the interactive flat panel to the serial output on your computer or room control system.

IMPORTANT

Do not use a null modem cable. Use only a standard RS-232 cable.

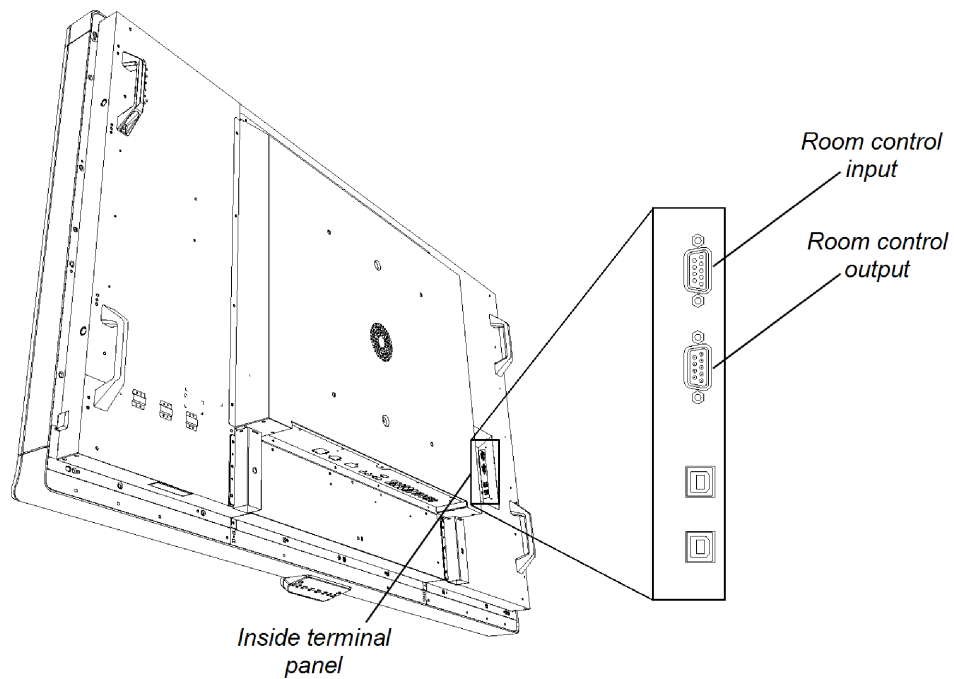

For more information about setting up and programming an RS-232 connection, see *Remotely managing your SMART Board 8070i interactive flat panel* (smarttech.com/kb/160469).

Connecting computers to your interactive flat panel

You can connect up to three computers simultaneously to your interactive flat panel:

- An installed room computer connected to USB 1 and the VGA
- An installed cable for the guest laptop connected to USB 2 and RGB/HV connection
- A side laptop connected to the USB 3 and HDMI 2 connector

i NOTE

This document describes the default USB and video connections. To customize the USB and video mapping, see *Configuring the video and touch input for your SMART Board 8070i interactive flat panel* (smarttech.com/kb/170065).

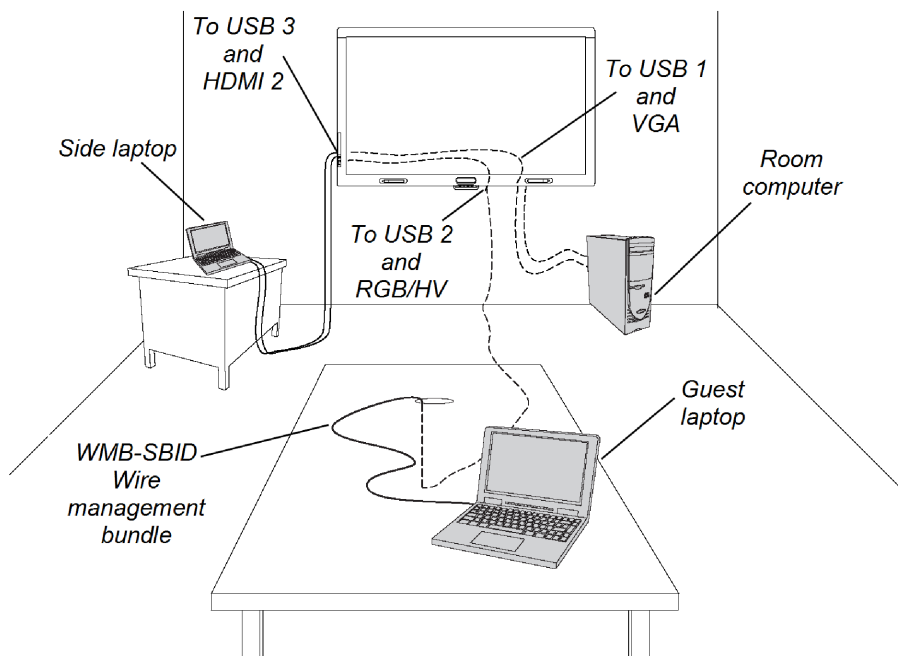

Interactive flat panel touch control and video input connections

The following table shows which touch control USB connection corresponds with which video input for each computer connection.

	Touch control	Video input	Installation steps
Room computer	USB 1 (inside panel)	VGA	page 19
Guest laptop connection	USB 2 (inside panel)	RGB/HV	page 20
Side laptop connection	USB 3 (side terminal panel)	HDMI 2	page 51

CHAPTER 3

Connecting computers and peripheral devices

i NOTE

A wire management bundle (part number WMB-SBID) for the guest laptop connection is available from your authorized SMART reseller. This 16' (5 m) bundle includes a USB cable and a RGB/HV to VGA video cable.

Connecting to power and your room computer

Your room computer is the default computer for your interactive flat panel. Connect this computer to your interactive flat panel with a VGA cable and a USB cable.

Room computer connection diagram

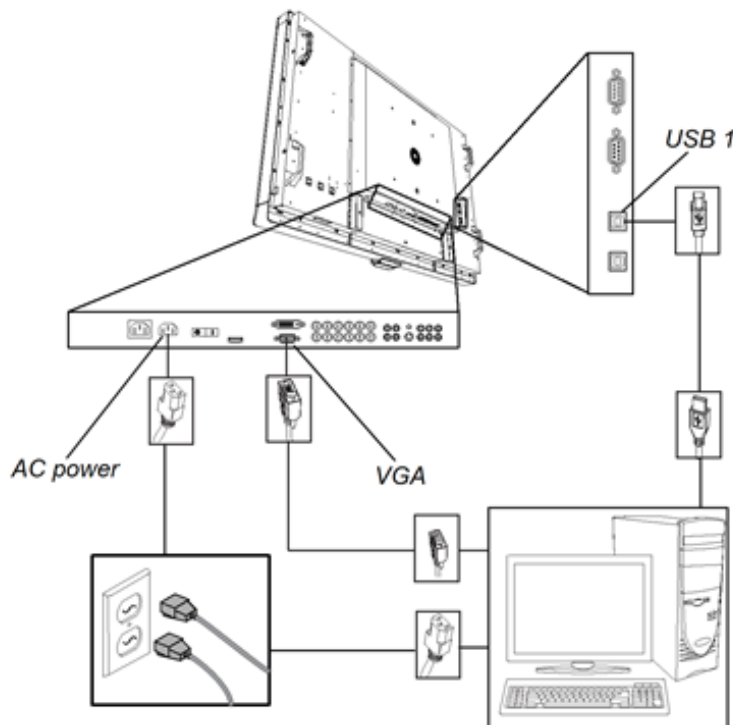



■ To connect your interactive flat panel to power and your room computer

1. Connect the included VGA cable from computer 1 to the **VGA** receptacle on the bottom terminal panel.
2. Connect the included USB cable from the **USB 1** receptacle on the inside terminal panel of the interactive flat panel to a USB receptacle on the computer.
3. Connect the included power cable from the **AC IN** connector on the bottom terminal panel to a power outlet.

CHAPTER 3

Connecting computers and peripheral devices

4. Connect the power cable from your computer to a power outlet.
5. Turn on your computer.
6. Turn on the main power switch on the bottom terminal panel, and then press the **Power** button  on the front control panel.
7. Using the remote control or the **Input** button  on the front control panel, set the interactive flat panel's input source to VGA.

Installing a guest laptop connection

You can install cabling that enables you to connect a second computer to your interactive flat panel from another location in the room, such as on a conference table. By installing this connection, you make use of connection points that might not be accessible when your interactive flat panel is wall-mounted.

You require a USB cable and a RGB/HV to VGA cable to install the guest laptop connection. You can purchase a wire bundle that includes these two connectors from your authorized SMART reseller. You may install these cables and run them through floors or walls to a nearby table. Refer to the interactive flat panel specifications document for ordering information.

Alternatively, your users can connect a laptop to the side terminal panel using the more accessible USB receptacle and HDMI input. For more information, see *Connecting a side laptop* on page 51. For a diagram of the various computer options, see *Connecting computers to your interactive flat panel* on page 18.

WARNING

Ensure that any cables extending across the floor to your SMART product are properly bundled and marked to avoid a trip hazard.

NOTE

You do not require a laptop to install this cabling.

CHAPTER 3

Connecting computers and peripheral devices

Guest laptop connection diagram

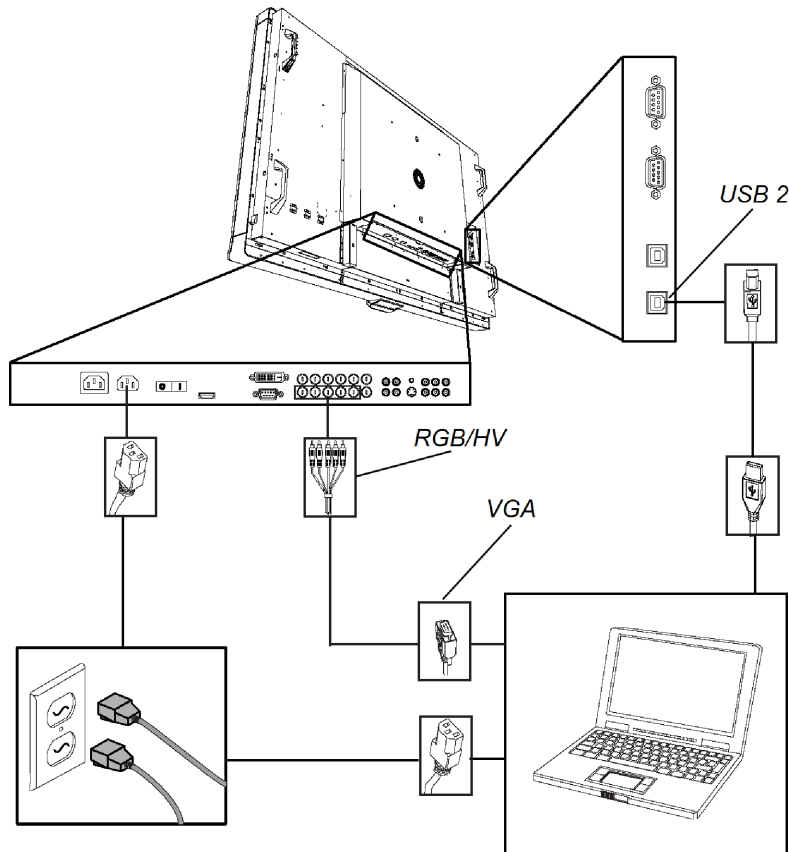

■ To setup the guest laptop connection location

1. Connect a USB cable to the **USB 2** receptacle on the inside terminal panel, and then run the cable to the laptop connection location, such as beside the interactive flat panel or on a conference table.
2. Connect a 5-BNC to VGA video cable to the **RGB/HV** interactive flat panel connection on the bottom terminal panel, and then run the cable to the remote connection location as above.

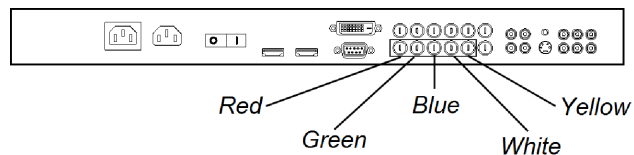

3. Bundle and cover the cables as appropriate to avoid a trip hazard.

To connect and use a guest laptop using this installed connection, see *Connecting a guest laptop* on page 49.

Disabling the USB receptacle on the side terminal panel

You can connect a USB drive or other USB device to the USB receptacle on the side terminal panel of your interactive flat panel, and then access the device from the room computer. For more information, see *Using the USB receptacle* on page 47.

You can also disable this USB receptacle so that it doesn't access any of the computers connected to your interactive flat panel.

CAUTION

Disconnect the power supply for your interactive flat panel before you disable the USB receptacle.

To disable the USB receptacle

1. Locate the oval cut-out on the back of your interactive flat panel. It's at the same height as the USB receptacle and very close to the receptacle.
2. Rotate the top of the cut-out using needle-nose pliers, and then grasp the bottom edge of the cut-out with the pliers.
3. Pry the cut-out away from your interactive flat panel.
You can see a black jumper on the circuit board inside the panel.
4. Pull the black jumper off of the circuit board with the pliers.

CAUTION

To prevent damage to the circuit board, do not touch the circuit board with the pliers.

IMPORTANT

You can install the jumper again to enable the USB receptacle.

Connecting peripheral devices to your interactive flat panel

Connect peripheral devices to the bottom terminal panel.

CAUTION

The AC power outlet is designated for a component of the SMART Board 8070ie-SMP interactive flat panel with appliance. Use this power outlet only as instructed by that product's documentation.

Bottom terminal panel

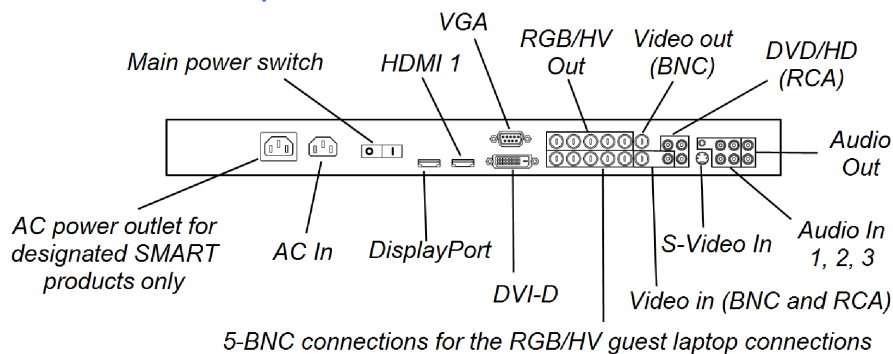

To connect a peripheral device

1. Turn off the interactive flat panel and the peripheral device.
2. Connect the peripheral device's input cables to the appropriate connectors on the bottom terminal panel.

NOTE

You can secure these cables with the included large clamps.

3. Turn on the interactive flat panel, and then turn on the peripheral device.

Chapter 4

Installing SMART software

Installing SMART Meeting Pro software	26
Installing SMART Notebook software	26

IMPORTANT

If you already have SMART Meeting Pro software or SMART Notebook™ collaborative learning software installed on your computer, ensure your computer has SMART Product Drivers 11 or later installed. For more information, see *Updating SMART Product Drivers* on page 55.

You need to install SMART software on the computer that's connected to your interactive flat panel in order to use the interactive flat panel. You can install either SMART Meeting Pro software or SMART Notebook software.

SMART Board 8070i-SMP interactive flat panels also include a SMART GoWire auto-launch cable that provides the features of SMART Meeting Pro software without installing the software on your computer. For more information about using the SMART GoWire auto-launch cable, see *Using a SMART GoWire cable* on page 50.

NOTE

For laptops that are only occasionally used for your interactive flat panel, you can use a SMART GoWire cable instead of installing SMART Meeting Pro software.

Once you install SMART Notebook software or SMART Meeting Pro software on the computer that's connected to your interactive flat panel, you have touch control of that computer's desktop. You can open files, move icons and write or erase digital ink using the included pens and eraser.

Installing SMART Meeting Pro software

You can download and install SMART Meeting Pro software from the SMART website.

IMPORTANT

Register your product at smarttech.com/registration so that you can obtain a software product key which is required for activation.

To download SMART Meeting Pro software

1. Go to smarttech.com/downloads.
2. Scroll to the *SMART Meeting Pro software* section.
3. Click **Choose a version**, and then select the version that you require.
4. Follow the on-screen instructions to save the executable file to your desktop.

To install SMART Meeting Pro software

1. Double-click the executable file.
2. Follow the on-screen instructions.

Installing SMART Notebook software

Install SMART Notebook software from the included DVD (SMART Board 8070i interactive flat panels only) or from smarttech.com/downloads.

IMPORTANT

Connect to the Internet before you install SMART software so that you can obtain a software product key (smarttech.com/registration) and download software updates.

To install SMART Notebook software

1. Place the included software DVD in your computer's DVD tray.
The installation wizard appears.
2. Follow the on-screen instructions. You'll be prompted to enter your product key. You can register your interactive flat panel at smarttech.com/registration to receive your product key.

CHAPTER 4

Installing SMART software

3. Click the **SMART Board** icon  in the notification area (Windows operating systems) or the Dock (Mac OS X operating system software), and then select **Check for Updates and Activation**.

The *SMART Product Update* window appears.

4. Follow the on-screen instructions to update your SMART Notebook software to the latest version.

Chapter 5

Using your interactive flat panel

Turning on and turning off your interactive flat panel	30
Using the infrared remote control	31
Installing batteries in the remote control	31
Infrared remote control sensor	32
Infrared remote control buttons	33
Getting started with your SMART Board interactive flat panel	35
About SMART Ink	35
SMART Ink Notes	35
SMART Ink Document Viewer	35
SMART Ink Toolbar	35
About your SMART software	36
SMART Product Drivers	36
SMART Notebook software	36
SMART Meeting Pro software	36
Writing or drawing in digital ink	36
Entering text on the interactive flat panel	37
Changing pen settings	37
Using Locked Ink mode	38
Erasing digital ink	38
Changing eraser settings	39
Manipulating objects	39
Browsing	43
Playing audio files on your interactive flat panel	46
Using the USB receptacle	47

This chapter includes information on how to use your interactive flat panel, turn on and turn off your interactive flat panel, control your computer by touching the screen, use the remote control and more.

Turning on and turning off your interactive flat panel

■ To turn on your interactive flat panel

1. Turn on your computer.
2. Press the **Power** button  on the front control panel.

You can also press the **POWER ON** button on the remote control.

Your computer's logon screen or desktop appears on your interactive flat panel.

IMPORTANT

If the power button light on the front control panel is off, either the interactive flat panel is not plugged in or the main power switch on the bottom terminal panel is turned off. To find the main power switch, see *Back view* on page 7.

■ To turn off your interactive flat panel

1. Turn off your computer.
2. Press the **Power** button  on the front control panel.

You can also press the **STANDBY** button on the remote control.

Using the infrared remote control

The infrared remote control enables you to turn on and turn off your interactive flat panel, change the input source, change the volume and more. You can also use the remote control to open the on-screen menu and then change the interactive flat panel's settings.

If the remote control doesn't respond, see *Resolving remote control issues* on page 71.

CAUTION

- Do not subject the remote control to strong shock.
- Keep the remote control away from liquids. If it gets wet, wipe it dry immediately.
- Do not expose the remote control to heat or steam.
- Do not open any part of the remote control other than the battery compartment.

IMPORTANT

The remote control system does not function when strong light strikes the remote control sensor or when there is an object between the remote control and its sensor.

Installing batteries in the remote control

Your remote control requires two 1.5V AA batteries.

WARNING

To reduce the risk associated with leaking batteries:

- use only AA type batteries
- do not mix used and new batteries
- orient the battery's plus (+) and minus (-) terminals according to the markings found on the remote control
- do not leave the batteries in the remote control for an extended period
- do not heat, disassemble, short or recharge the batteries, or expose them to fire or high temperature
- avoid eye and skin contact if batteries have leaked
- dispose of exhausted batteries and product components in accordance with applicable regulations

CHAPTER 5

Using your interactive flat panel

To install batteries in the remote control

1. Press the tab on the underside of the remote control, and then slide it to open the cover.
2. Remove the batteries if they are present.
3. Insert two new 1.5V AA batteries in the remote control. Ensure the + and - markings on the batteries align with the markings in the remote control.
4. Replace the cover.

Infrared remote control sensor

The infrared remote control sensor is located on the front control panel. It enables you to control your interactive flat panel from an angle of 30° and within a distance of 23' (7 m) using the included remote control.

IMPORTANT

The remote control might not function when the infrared remote control sensor is blocked or when it is in direct sunlight or strong lighting.

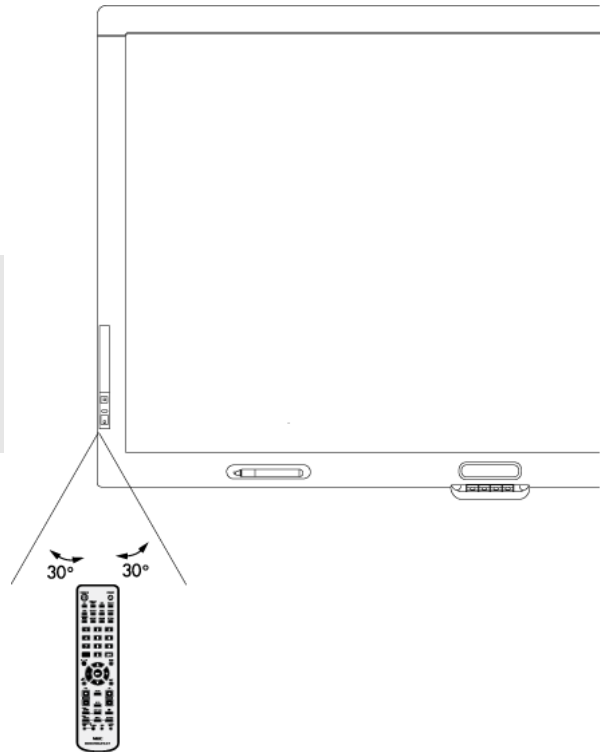

CHAPTER 5

Using your interactive flat panel

Infrared remote control buttons

The remote control enables you to access on-screen menus and 1 change display and input settings.

Use the remote control's POWER ON button turn on your interactive flat panel and the STANDBY button to turn it off.

Use the remote control's input buttons to change input sources when switching between the room computer and guest laptops.

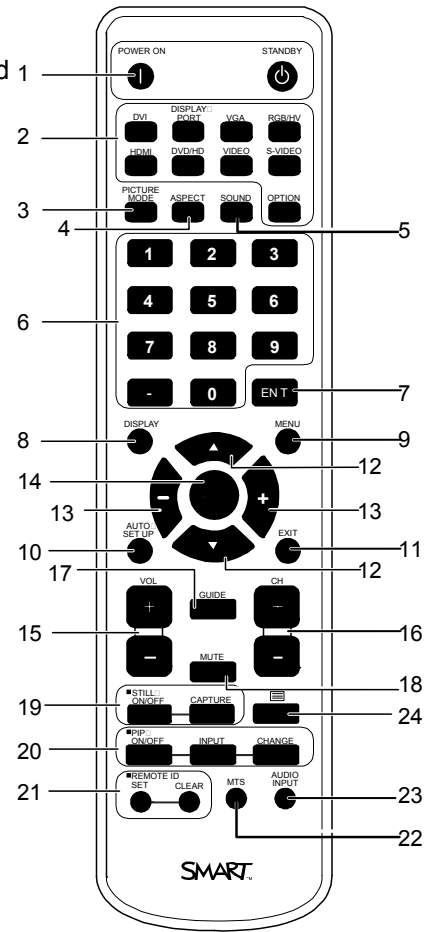

Number	Function	Description
1	POWER ON STANDBY	Turns on your interactive flat panel Turns off your interactive flat panel
2	Input buttons	Selects input signal for the interactive flat panel
3	PICTURE MODE	Selects picture mode
4	ASPECT	Selects picture aspect
5	SOUND	Selects artificial surround sound
6	Number pad	Press buttons on the number pad to set and change passwords, change channels or to customize or change settings
7	ENT	Enter
8	DISPLAY	Turns on and turns off the on-screen display menu
9	MENU	Turns on and turns off the menu mode
10	AUTO SET UP	Enters auto setup menu

CHAPTER 5

Using your interactive flat panel

Number	Function	Description
11	EXIT	Returns to previous menu
12	Up/Down	Moves the highlighted area up or down to select items within the on-screen display menu
13	+/-	Increases or decreases the adjustment level within the on-screen display menu
14	SET	Makes selection
15	VOL +/-	Increases or decreases audio output level
16	CH +/-	Changes the channel for the interactive flat panel
17	GUIDE	Not in use
18	MUTE	Mutes audio inputs for your interactive flat panel
19	STILL ON/OFF CAPTURE	Turns on and off the still picture mode Captures a still image
20	PIP ON/OFF PIP INPUT PIP CHANGE	Toggles between PIP, POP, side-by-side and side-by-side Selects the "picture-in-picture" input signal Replaces to the main picture and sub-picture.
21	REMOTE ID	Activates Remote ID function
22	MTS	Not in use
23	Audio input	Selects audio input source
24	Closed caption	Activates closed captioning

Getting started with your SMART Board interactive flat panel

Using your SMART Board interactive flat panel, you can write, draw and erase digital ink, manipulate objects and browse content on the screen.

About SMART Ink

SMART Ink enables you to write and draw in digital ink over open applications, files, folders, websites and any other open window on your computer.

You can write over an Internet browser window, highlight content on your screen and write over a video without pausing the video and without interfering with your ability to interact with the video. When you move, resize or minimize a window, the ink stays with the window.

You can convert your digital ink notes to text. You can also move, erase and capture your notes as an image and save it to your SMART software.

When you open an application that has its own ink tools, you can turn off SMART Ink, and then use the application's ink tools to write.

For more information see SMART Ink for Windows (smarttech.com/SupportInk1Windows) or SMART Ink for Mac (smarttech.com/SupportInk1Mac) on the SMART Support website.

SMART Ink Notes

SMART Ink Notes enable you to write in digital ink anywhere on your desktop. When you write outside of the open windows on your computer, a SMART Ink Note appears and you can write inside the note.

SMART Ink Document Viewer

If you're using a Windows operating system, the SMART Ink Document Viewer enables you to view your PDF files and to write in digital ink over your files.

SMART Ink Toolbar

If your computer is connected to a SMART interactive product, SMART Ink starts automatically when you start your computer and the SMART Ink toolbar appears in the title bar of each open window on your computer.

Use the toolbar to select ink properties for that window and to perform common tasks such as capturing your notes.

CHAPTER 5

Using your interactive flat panel

About your SMART software

SMART Ink and SMART Product Drivers are included with SMART Notebook collaborative learning software and SMART Meeting Pro software.

SMART Product Drivers

SMART Product Drivers enables your computer to detect input from your interactive flat panel.

SMART Ink works with SMART Product Drivers to enable you to write on your screen in digital ink using your interactive flat panel's pen or your finger.

NOTE

In most cases, SMART Product Drivers installs automatically when you install your SMART software. To ensure you have the most recent version of SMART Product Drivers installed, see *Updating SMART Product Drivers* on page 55.

SMART Notebook software

You can write in SMART Notebook software using your SMART interactive product's pen or your finger. The ink becomes part of your .notebook file. For more information, see the SMART Notebook software support page for Windows (smarttech.com/SupportNotebook11Windows) or SMART Notebook software support page for Mac OS X operating system software (smarttech.com/SupportNotebook11Mac).

SMART Meeting Pro software

You can write in SMART Meeting Pro software's Whiteboard mode using your SMART interactive product's pen or your finger. The ink becomes part of your .notebook file. For more information, see the SMART Meeting Pro support page (smarttech.com/SupportMeetingPro3Windows).

Writing or drawing in digital ink

Using the pen supplied with your interactive flat panel, you can write or draw digital ink over SMART software and other programs.

To write or draw digital ink

1. Pick up the pen.
2. Write or draw on the screen.

TIP

Don't rest your elbow or the palm of your hand on the screen while you're writing.

Entering text on the interactive flat panel

You can enter text in text boxes on the interactive flat panel using the on-screen keyboard or a keyboard attached to your computer.

To enter text

1. Select the area where you want to enter text using your finger or a mouse connected to the computer.
2. Type on a connected keyboard or on-screen keyboard.

TIP

Press the keyboard button on the interactive flat panel to open the on-screen keyboard.

Changing pen settings

You can change your pen settings, including line size and fill effects.

To change pen settings

1. Press the **SMART Board** icon  in the notification area (Windows operating systems) or the Dock (Mac OS X operating system software).

OR

Press the **SMART Meeting Pro** icon  in the notification area.

2. Press **SMART Settings**.
3. Select **Pen and Button Settings** in the drop-down list.
4. Press **Black Pen Settings**  to customize the black pen.

Press **Blue Pen Settings**  to customize the blue pen.

Press **Red Pen Settings**  to customize the red pen.

Press **Green Pen Settings**  to customize the green pen.

The *Properties* dialog box appears.

5. Press **Line Style**.
6. Adjust the color, thickness, line end and line style.
7. Press **Fill Effects**.
8. Adjust the transparency.

CHAPTER 5

Using your interactive flat panel

9. Press **Save Tool Settings** to save your settings.
10. Optionally, repeat steps 4 through 9 to customize other pens.
11. Press **OK** to close SMART Settings.

Using Locked Ink mode

Locked Ink mode enables you to write or draw digital ink using large objects, including eraser-sized objects.

■ To use Locked Ink mode

Press and hold a color button on the color select module until the light flashes.

■ To end Locked Ink mode

Press any color button that isn't flashing on your color select module.

Erasing digital ink

■ To erase digital ink

Pick up the eraser, and then press the eraser on the screen and move it over the digital ink you want to erase.

OR

Using your flattened fist, press the screen and move your hand over the digital ink you want to erase.



CHAPTER 5

Using your interactive flat panel

Changing eraser settings

You can change the eraser size for either a larger or smaller eraser area.

■ To change eraser settings

1. Press the **SMART Board** icon  in the notification area (Windows operating systems) or the Dock (Mac OS operating system software), and then select **SMART Settings**.

OR

Press the **SMART Meeting Pro** icon  in the notification area, and then select **SMART Settings**.

2. Press **SMART Hardware Settings**.
3. Select **Pen and Button Settings** in the drop-down list.

4. Press **Eraser Settings** .

5. Select an eraser size.
6. Press **OK** to save your settings.
7. Press **OK** to close SMART Settings.

Manipulating objects

Objects include icons, buttons, links and other components of programs that appear on your screen. You can manipulate these objects on your interactive flat panel as described below.

■ To select or clear the selection of an object

Quickly press and release the object.

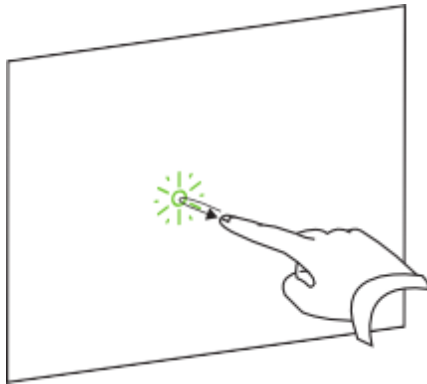

CHAPTER 5

Using your interactive flat panel

i NOTES

- This gesture performs a standard mouse click.
- This gesture starts programs if your operating system is set to start applications on a single click.

■ To double-click an object

Quickly press and release the object twice in the same spot.

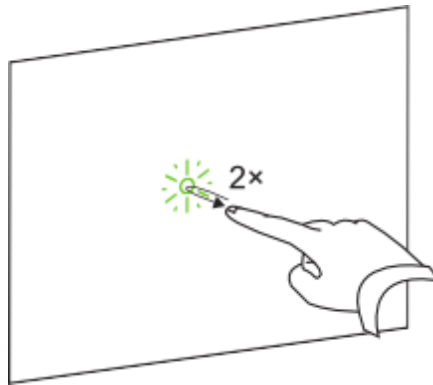

i NOTE

This gesture starts programs if your operating system is set to start applications on a double-click.

■ To right-click or Control-click an object

Press and hold the object.

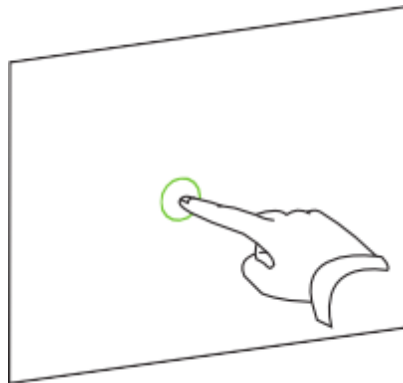

OR

CHAPTER 5

Using your interactive flat panel

Using two fingers on the same hand, press and hold the object with your left finger, and then press the screen once with your right finger.

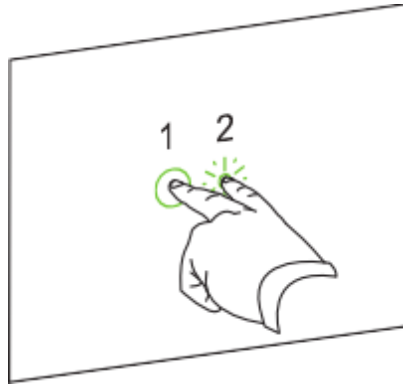

OR

Press the **Right-Click** button on the pen tray, and then press the object.

■ To move an object

1. Press and hold the object.
2. Keeping your finger on the screen, slowly move the object.
3. When you reach the position you want to move the object to, release your finger.

CHAPTER 5

Using your interactive flat panel

■ To resize an object

1. Using one finger on each hand, press the screen at opposite ends of the object.
2. Drag your fingers in opposite directions to enlarge the object.

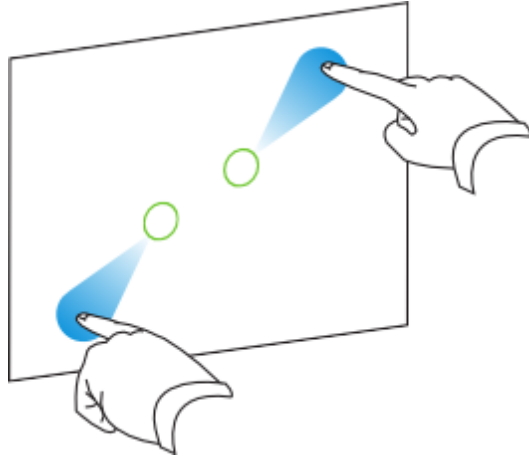

OR

Drag your fingers toward each other to reduce the object.

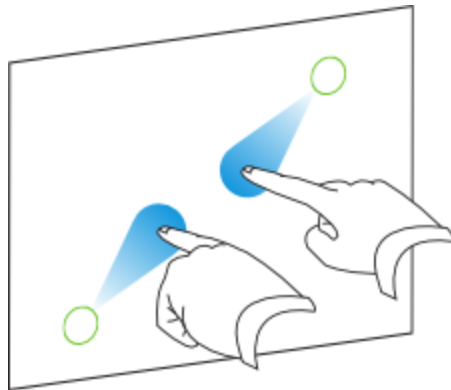

CHAPTER 5

Using your interactive flat panel

■ To rotate an object

1. Using one finger on each hand, press the screen at opposite ends of the object.
2. Rotate your fingers in the direction you want to rotate the object.

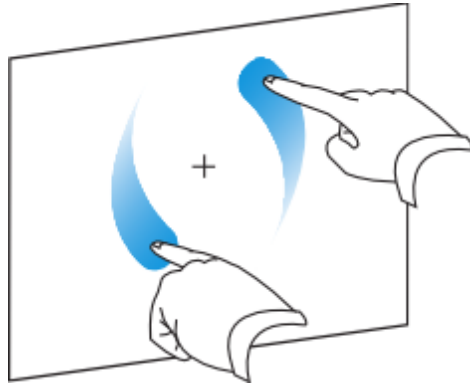

3. When you reach the angle you want to rotate the object to, release your fingers.

Browsing

In addition to manipulating objects, you can browse content on your screen.

■ To display the next page

Press the screen, and then quickly press again directly to the right of that point.

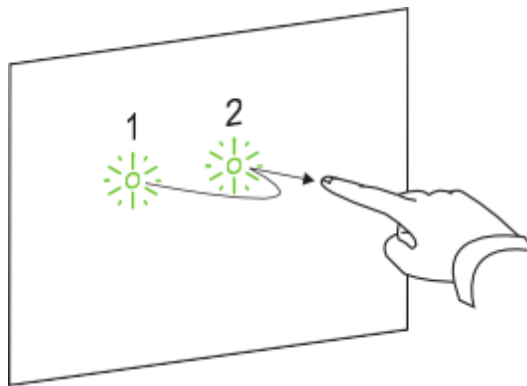

OR

CHAPTER 5

Using your interactive flat panel

Quickly flick your finger right across the screen.

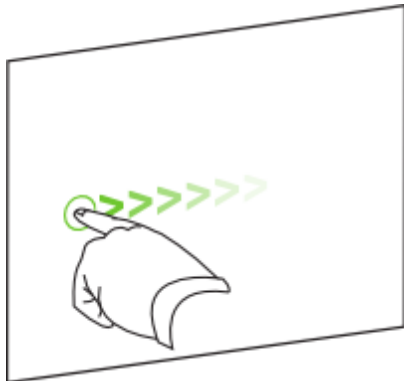

■ To display the previous page

Press the screen, and then quickly press again directly to the left of that point.

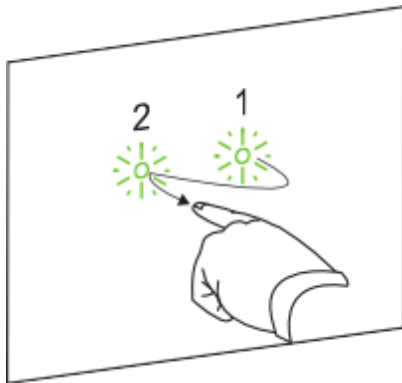

OR

Quickly flick your finger left across the screen.

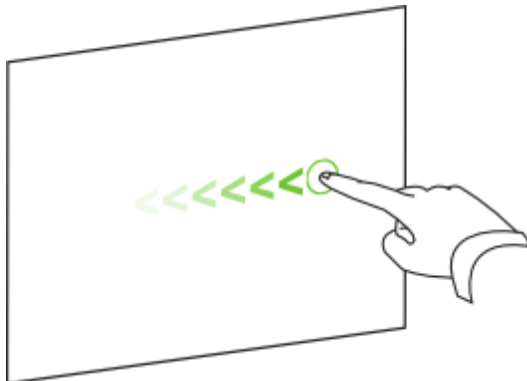

CHAPTER 5

Using your interactive flat panel

■ To zoom in or out

1. Using one finger on each hand, press the screen at opposite ends of the object.
2. Drag your fingers in opposite directions to zoom in.

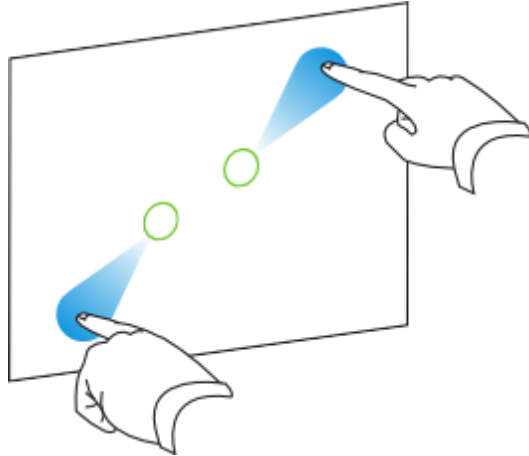

OR

Drag your fingers toward each other to zoom out.

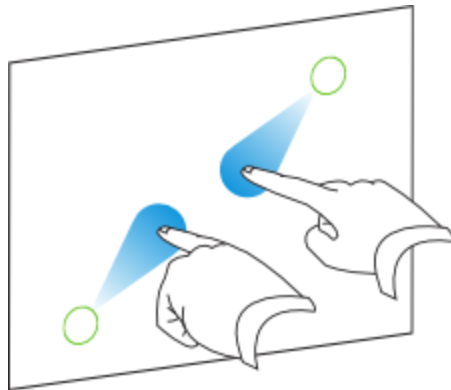

CHAPTER 5

Using your interactive flat panel

■ To pan horizontally or vertically

1. Using two fingers on the same hand, press and hold the screen.
2. Keeping your fingers on the screen, move up, down, left or right.

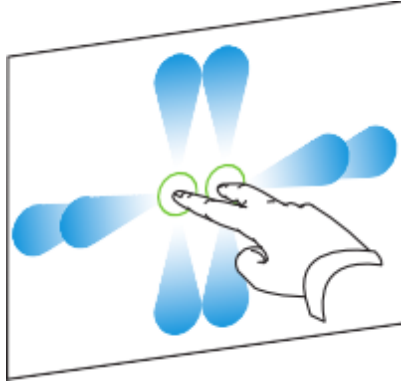

3. When you reach the area you want to view, release your fingers.

Playing audio files on your interactive flat panel

Your interactive flat panel includes two speakers that play audio files or the audio portion of a video file.

When you play an audio file or a video file on a computer connected to your interactive flat panel, the file is streamed through the USB connection between your computer and your interactive flat panel, not through the video connection.

IMPORTANT

If your computer uses Mac OS X operating system software, you must set the audio output to USB.

■ To switch your Mac computer to USB audio output

1. Press the **Apple** menu , and then select **System Preferences**.
2. Press **Sound** under the Hardware section.
3. Press the **Output** tab.
4. Select **SBID 8070i/USB**.
5. Close System Preferences.

Using the USB receptacle

You can connect a USB drive or device to the USB receptacle on the side terminal panel on your interactive flat panel, and then access it from the room computer connected to VGA and USB 1.

i NOTE

To disable the USB A receptacle on the side terminal panel, see *Disabling the USB receptacle on the side terminal panel* on page 22.

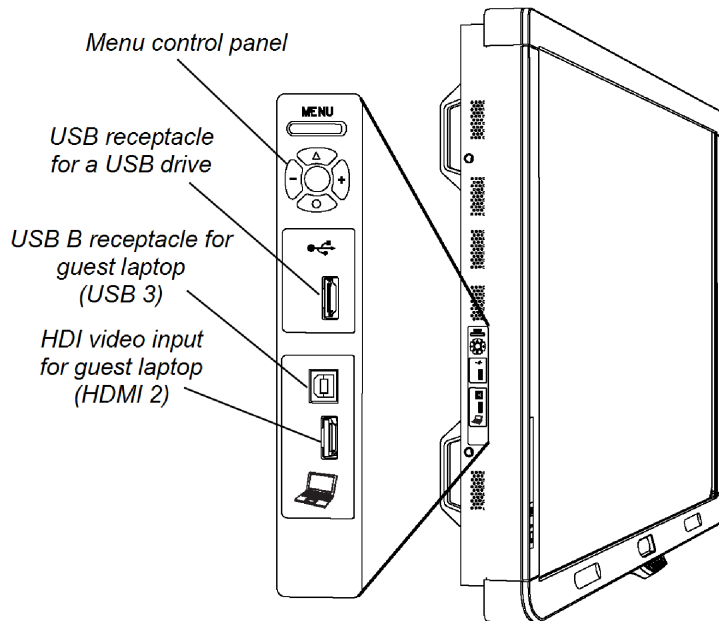

■ To use the USB receptacle

1. Press the **VGA** button on the remote control.

You can also press the **Input** button  on the front control panel until it is set to VGA.

2. Connect a USB device to the USB receptacle.
3. Use the room computer to access the content on your USB device.

Chapter 6

Using guest laptops with your interactive flat panel

Connecting a guest laptop	49
Using a SMART GoWire cable	50
Connecting a side laptop	51

Connecting a guest laptop

You can connect a second laptop to the installed USB cable and video cable that is connected to the back terminal panel of your interactive flat panel. If those cables aren't installed, connect the laptop to the side terminal panel (see *Connecting a side laptop* on page 51). For a diagram of the various computer options, see *Connecting computers to your interactive flat panel* on page 18.

IMPORTANT

The laptop must have SMART Product Drivers installed. If it doesn't, you need to connect the laptop to the interactive flat panel using a SMART GoWire cable. If you purchased an SBID8070i-SMP or SBID8070ie-SMP model, you can use the supplied SMART GoWire cable to connect your laptop to the interactive flat panel. For more information, see *Using a SMART GoWire cable* on the next page.

To connect a laptop

1. Place the laptop beside the end of the wire bundle at the guest laptop connection.
2. Connect the installed USB cable to a USB receptacle on the laptop.
3. Connect the VGA cable connector to the laptop.
4. Turn on the laptop.
5. Press the **RGB/HV** button on the remote control.

OR

Press the **Input** button  on the front control panel until the input source is RGB/HV.

CHAPTER 6

Using guest laptops with your interactive flat panel

■ To return to using the room computer

Press the **VGA** button on the remote control.

OR

Press the **Input** button  on the front control panel until the input source is VGA.

Using a SMART GoWire cable

Any computer connected to your interactive flat panel requires SMART software. Typically, you install this software on your room computer so that it's always ready to use.

However, if you want to connect a laptop that doesn't have SMART software installed, you can connect a SMART GoWire cable from the laptop to the USB cable for your interactive flat panel. The SMART GoWire cable enables you to have touch control of your laptop and use SMART Meeting Pro software without installing the software on your laptop.

SMART Board 8070i-SMP interactive flat panels include a SMART GoWire cable. Additional SMART GoWire cables can be purchased from your authorized SMART reseller (smarttech.com/where).

IMPORTANT

Your interactive flat panel supports the SMART GoWire cable with SMART Meeting Pro software only. It does not support the SMART GoWire cable with SMART Notebook software.

■ To use a SMART GoWire cable

1. Connect a video cable from your interactive flat panel to your laptop.
2. Connect the USB cable from the USB receptacle on your interactive flat panel to your laptop.
3. Change the video input to your laptop's video connection using the remote control or the front control panel.
4. Disconnect the USB cable from your laptop, and then connect it to the SMART GoWire cable's USB A receptacle.

IMPORTANT

If the SMART GoWire cable is not connected to your interactive flat panel through a USB cable, you have access to SMART Meeting Pro software on your laptop for five minutes, and then the software closes.

5. Connect the SMART GoWire cable's USB connector to your laptop.

The *AutoPlay* dialog box appears.

CHAPTER 6

Using guest laptops with your interactive flat panel

6. Select **Start SMART Meeting Pro**.

SMART Meeting Pro software starts. You have touch control of your laptop on your interactive flat panel and can use SMART Meeting Pro software while your laptop is connected to your interactive flat panel.

■ To disconnect a SMART GoWire cable

1. Save your SMART Meeting Pro software file to your laptop, if required. You can save the file as a .ppt, .pdf or .notebook file.

IMPORTANT

You can open a .notebook file on a computer that has SMART Meeting Pro software or SMART Notebook software installed or that is connected to a SMART product through a SMART GoWire cable only.

2. Press the SMART Meeting Pro icon in the notification area, and then select **Exit**.
3. Disconnect the SMART GoWire cable from your laptop and the USB cable for your interactive flat panel.

Connecting a side laptop

You can connect a side laptop to the side terminal panel of the interactive flat panel. When a side laptop is connected, the laptop's desktop is displayed on the interactive flat panel and touch interactivity is enabled. For a diagram of the various computer options, see *Connecting computers to your interactive flat panel* on page 18.

IMPORTANT

The side laptop must have SMART Product Drivers installed. If it does not, you need to connect the laptop to the interactive flat panel using a SMART GoWire cable. If you purchased an SBID8070i-SMP or SBID8070ie-SMP model, you can use the supplied SMART GoWire cable to connect your side laptop to the interactive flat panel. For more information, see *Using a SMART GoWire cable* on the previous page.

CHAPTER 6

Using guest laptops with your interactive flat panel

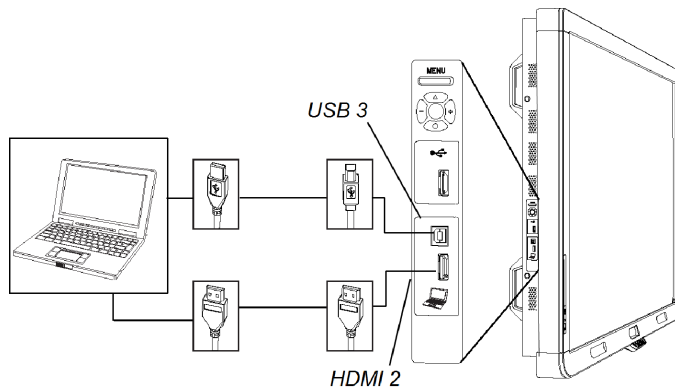

■ To connect a side laptop

1. Connect an HDMI cable from the side laptop's HDMI input to your interactive flat panel's side terminal panel.
2. Connect a USB cable from the laptop's USB receptacle to your interactive flat panel's side terminal panel.

IMPORTANT

The USB A receptacle is for USB devices only. Do not connect the side laptop to this receptacle.

3. Turn on the laptop.
4. Press the **HDMI** input button on the remote control twice.

OR

Press the **Input** button  on the front control panel until the input source is HDMI 2.

■ To return to using the room computer

1. Press the **VGA** button on the remote control.
- OR
2. Disconnect the side laptop from the interactive flat panel if required.

Chapter 7

Maintaining your interactive flat panel

Updating your SMART software and firmware	53
Updating SMART software	53
Updating your interactive flat panel firmware	54
Updating SMART Product Drivers	55
Calibrating your interactive flat panel	56
Orienting your interactive flat panel	57
Replacing a pen nib	57
Cleaning the screen	58
Cleaning the camera windows and reflective tape	58
Maintaining ventilation	59
Preventing condensation	59
Checking the interactive flat panel installation	60
Removing your interactive flat panel	60
Transporting your interactive flat panel	61

If you properly maintain your interactive flat panel, it will provide years of use.

Updating your SMART software and firmware

To use touch control and digital ink on your interactive flat panel, you require SMART software on your computer and up-to-date firmware on your interactive flat panel.

Updating SMART software

Once you have SMART software installed on your computer, you can check for software updates with SMART Product Update by selecting **Help > Check for Updates** in the software or by browsing to smarttech.com/downloads.

To check for software updates

1. Start your SMART software program.
2. Click **Help > Check for Updates**.

IMPORTANT

If you do not see the *Check for Updates* option, contact your network administrator.

3. Click the **Update** button beside the software you want to update.
SMART software updates.

IMPORTANT

When you update SMART software on your computer, a firmware update for your interactive flat panel could download to your computer. The next time you connect your computer to your interactive flat panel you are informed that there is a firmware update for the processor in the interactive flat panel. For more information, see *Updating your interactive flat panel firmware* below.

Updating your interactive flat panel firmware

CAUTION

Only a system administrator should update interactive flat panel firmware.

Your interactive flat panel uses firmware on its processor. After you update SMART software, a new firmware executable file could save on your computer. When you connect a computer with this file to your interactive flat panel, your interactive flat panel detects this executable file, and then prompts you to run the file to update the firmware.

CAUTION

- Do not disconnect your interactive flat panel from your computer during the firmware update process.
- Do not touch your interactive flat panel's screen or input button during the firmware update process.
- Do not turn off your computer or your interactive flat panel during the firmware update process.

■ **To update your interactive flat panel firmware**

1. Ensure your interactive flat panel is connected to your computer.
2. Launch the firmware updater at the following location:

Windows computers: **C:\Program Files\SMART Technologies\SMART Product Drivers\SMARTFirmwareUpdater.exe.**

Mac computers: **HD\Applications\SMART Product Drivers\SMARTFirmwareUpdater.app.**
3. Follow the on-screen instructions using your computer's mouse and keyboard. Don't touch the interactive flat panel screen.
4. Select the check box for the SMART interactive product you want to update, and then click **Next**.

A progress bar appears.

i NOTE

SC14 refers to the SMART Board 8000 series interactive flat panel's serial controller.

5. When the installation is complete, calibrate your interactive flat panel. See *Calibrating your interactive flat panel* on the next page

Updating SMART Product Drivers

To use touch control and digital ink on your interactive flat panel, you require SMART Product Drivers 11 or later on your computer.

■ **To update SMART Product Drivers**

1. Click the **SMART Board** icon  in the notification area (Windows operating systems) or the Dock (Mac OS X operating system software), and then select **Check for Updates and Activation**.

OR

Click the **SMART Meeting Pro** icon  in the notification area and then select **Check for Updates and Activation**.

The *SMART Product Update* window appears.

2. If your version of SMART Product Drivers is up-to-date, click **OK**.
If your version of SMART Product Drivers needs to be updated, click **Update**.
3. Follow the on-screen instructions to update SMART Product Drivers to the latest version.

Calibrating your interactive flat panel

Digital cameras in the corners of the interactive flat panel track the position of the pens, eraser and your finger on the interactive surface, and then send the information to the SMART software, which interprets this information as mouse clicks, digital ink or ink removal in the appropriate location. Calibration determines the position and angles of the cameras to accurately identify the location of touches on your interactive flat panel.

IMPORTANT

If an error message appears while you are calibrating your interactive flat panel, contact SMART Support (smarttech.com/contactsupport).

To calibrate your interactive flat panel

1. Press the **SMART Board** icon  in the notification area (Windows operating systems) or the Dock (Mac OS X operating system software).

OR

Press the **SMART Meeting Pro** icon  in the notification area.

2. Select **SMART Settings**.

SMART Settings appears.

3. Press **SMART Hardware Settings**.

4. If you have more than one SMART product connected, select the interactive flat panel.

5. Select **Advanced Settings** from the drop-down list.

6. Press **Calibrate**.

The calibration screen appears. This can take a few moments.

7. Press the red target with the tip of an interactive flat panel pen. Hold the tip at the center of the target until the target turns green, and then lift the pen.

The target moves to the next location.

NOTE

You can calibrate a target again by pressing the LEFT ARROW key on your keyboard, or the **Keyboard** button or **Right-click** button on the color select module.

8. Continue pressing targets until the calibration is complete.

A message appears stating that the calibration was successful, and then the orientation screen appears.

9. Orient your interactive flat panel.

Orienting your interactive flat panel

When the location of your touch is misinterpreted (a pointer appears a distance from the actual contact), orient your interactive flat panel.

■ To orient the interactive flat panel

1. Press the orientation button  on the color select module.

The orientation window opens.

2. Use an interactive flat panel pen to press the red targets as they appear. Hold the tip of the pen at the center of each target, and then lift the pen. When you lift the pen, the target moves to the next orientation point.



IMPORTANT

Hold the pen perpendicular to the screen.

3. Continue until you've pressed all the targets.

The orientation window closes.

If this doesn't correct inaccurate touch control, calibrate your interactive flat panel. For more information, see *Calibrating your interactive flat panel* on the previous page.

Replacing a pen nib

To prevent damage to your interactive flat panel's anti-glare coating, replace your pen nib if it becomes worn. Eight replacement pen nibs are included with your pens, and you can purchase additional replacements from your authorized SMART reseller (smarttech.com/where).

■ To replace a pen nib

1. Grasp the worn nib on your pen with a pair of pliers, and then pull and twist the nib loose.
2. Press the replacement nib into the pen.

Cleaning the screen

Follow these instructions to clean the interactive flat panel screen without damaging its anti-reflective coating or other product components.

CAUTION

- Do not use permanent or dry-erase markers on the screen. If dry-erase markers are used on the screen, remove the ink as soon as possible with a lint-free, non-abrasive cloth.
- Do not rub the screen with a dense or rough material.
- Do not apply pressure to the screen.
- Do not use cleaning solution or glass cleaner on the interactive flat panel screen, as they can deteriorate or discolor the screen.
- Avoid touching the silver reflective tape between the screen and the bezel and ensure that it stays dry. Damage to this strip affects touch interactivity.

To clean the interactive flat panel screen

1. Shut off your computer, and then disconnect the power sources for your computer and your interactive flat panel.
2. Wipe the screen with a lint-free, non-abrasive cloth.

Cleaning the camera windows and reflective tape

The DVIT technology in your interactive flat panel uses four cameras in the corners of the frame and the reflective material between the screen and the bezels. Excessive dust buildup on the camera windows or reflective tape can impair touch performance.

These areas should be inspected annually for dust and should be cleaned if any obvious dust buildup has occurred.

CAUTION

- Do not use compressed air to clean the camera windows or borders.
- Do not use water, chemicals or cleaning agents.

■ **To clean the camera windows and reflective tape**

1. Gently wipe the reflective tape along the sides of your interactive flat panel screen.
2. Gently wipe the camera windows in the bottom corners and the reflective strip across the bottom of your interactive flat panel screen.

Maintaining ventilation

Your interactive flat panel requires ventilation to enable the cooling fans to function. Dust buildup in the ventilation holes compromises cooling and leads to product failure.

 **CAUTION**

Avoid setting up or using your interactive flat panel in an area with excessive levels of dust, humidity or smoke.

- Clean accessible ventilation holes monthly with a dry cloth.
- Use a vacuum cleaner with a narrow hose end fitting to clear the back ventilation holes annually. You might have to remove the interactive flat panel from your wall. For more information on removing your interactive flat panel see *Removing your interactive flat panel* on the next page.

Preventing condensation

Your interactive flat panel screen contains layers of glass that can collect condensation, especially in the following conditions:

- Temperature extremes with high humidity
- Rapid changes in humidity, which can occur when you operate the product near water, such as a sink, pool, kettle or air conditioner ventilator
- Direct exposure to sunlight

■ **To evaporate condensation from your interactive flat panel**

1. Remove the humidity source from the interactive flat panel, if possible.
2. Adjust the room temperature to normal operating ranges.
3. Turn on the interactive flat panel for 2–3 hours.

If the screen condensation doesn't evaporate, contact SMART Support (smarttech.com/contactsupport).

Checking the interactive flat panel installation

Inspect your interactive flat panel installation frequently to ensure that it remains securely installed.

- Check the mounting location for signs of damage or weakness that can occur over time.
- Check for loose screws, gaps, distortions or other issues that could occur with the mounting apparatus.

If you find an issue, refer to a professional installer.

Removing your interactive flat panel

To safely remove your interactive flat panel, use four or more professional installers.

WARNING

- Do not attempt to move the interactive flat panel using your own strength. The interactive flat panel is very heavy.
- Do not move the interactive flat panel by connecting a rope or wire to the handles on the back. The interactive flat panel can fall and cause personal injury and product damage.

IMPORTANT

Follow the instructions included with the floor stand or mounting apparatus.

To remove the interactive flat panel

1. Turn off your interactive flat panel and unplug the power cable from the wall outlet.
2. Remove all accessible cables and connectors.
3. Attach the M12 eyebolts for your lifting equipment. For more information, see *Wall-mounting your interactive flat panel* on page 12.
4. Lift your interactive flat panel from its mounting location.

CAUTION

- Do not leave the interactive flat panel face up, face down or upside down for an extended period of time as it could cause permanent damage to the screen.
- Do not place the interactive flat panel on a sloping or unstable cart, stand or table, because the interactive flat panel could fall, resulting in injury or severe product damage.

CHAPTER 7

Maintaining your interactive flat panel

CAUTION

- Do not leave the interactive flat panel face up, face down or upside down for an extended period of time as it could cause permanent damage to the screen.
- Do not place the interactive flat panel on a sloping or unstable cart, stand or table, because the interactive flat panel could fall, resulting in injury or severe product damage.

Transporting your interactive flat panel

Save your original packaging so that you can repack your interactive flat panel with as much of the original packaging as possible. This packaging was designed with optimal shock and vibration protection. If your original packaging isn't available, you can purchase the same packaging directly from your authorized SMART reseller (smarttech.com/where).

CAUTION

Transport your interactive flat panel only in original or replaced packaging. Transporting your interactive flat panel without correct packaging voids your warranty and could lead to product damage.

Chapter 8

Troubleshooting for your interactive flat panel

Resolving image issues	63
Diagnosing blank screen issues using the front control panel lights	63
Resolving poor image quality	65
Resolving touch control and digital ink issues	67
Resolving audio issues	70
Resolving remote control issues	71
Resolving issues using the SMART Connection Wizard	72
Resolving issues using SMART Board Diagnostics	73
Checking the camera view	73

This chapter provides you with the information necessary to solve simple issues that can occur with your interactive flat panel. If issues persist, or aren't covered in this chapter, contact SMART Support (smarttech.com/contactsupport).

Resolving image issues

Complete the following steps if your interactive flat panel doesn't display an image correctly or doesn't display any image at all.



Diagnosing blank screen issues using the front control panel lights

Use the following troubleshooting table when your computer is turned on, but you don't see an image on the interactive flat panel screen.

Begin by looking at the interactive flat panel system status light and the power light in the front control panel.

CHAPTER 8

Troubleshooting for your interactive flat panel

Power light	Status light	Causes	Solutions
Off	Off	The interactive flat panel isn't connected to a power source.	Connect your interactive flat panel's power cable to a power outlet (see page 19).
		The main power switch is off.	Turn on the main power switch on the terminal panel (see page 7).
Solid red	Off	The interactive flat panel is turned off.	Press the power button on the front control panel or the remote control.
Solid amber or red	Red	The computer is off.	Turn on your computer.
		The computer isn't connected to your interactive flat panel.	Connect your computer to your interactive flat panel with the required cable (see page 18).
		The interactive flat panel isn't set to the correct video input source.	Select your computer's input source (typically VGA, RGB/HV or HDMI 2) using the remote control. OR Press the Power button  until the Input button  is blue, and then press the Input source button until your computer's desktop appears.
Solid green	Flashing amber	The interactive flat panel is updating firmware.	Do not touch the interactive flat panel. For more information, see page 53.
Solid green	Flashing green	The interactive flat panel detects a computer, but SMART Product Drivers isn't installed or isn't running. (For more information, see page 67).	Install SMART software on your computer (see page 25) or install a SMART GoWire cable (see page 50).
Solid green	Solid green	The interactive flat panel detects a computer with SMART Product Drivers installed.	Normal operation.

Resolving poor image quality

Symptom	Causes	Solution
The image is too large, too small or doesn't completely fill the screen.	The computer's video resolution settings don't match your interactive flat panel's native resolution.	<p>The interactive flat panel's native resolution is 1920 × 1080 at 60 Hz.</p> <p>If your computer can't support this resolution, consider one of the following 16:9 resolutions as an alternative:</p> <ul style="list-style-type: none"> • 1600 × 900 • 1366 × 768 • 1280 × 720 <p>Other resolutions could result in image distortion or black bars around the desktop.</p>
The screen resolution is correct, but the image is surrounded by black bars.	The computer's video card is underscanning the image.	<p>Turn off or adjust the overscan/underscan feature in the video card driver software until the image fits the screen resolution. Refer to your computer's video card help for more information.</p> <div style="background-color: #f0f0f0; padding: 5px; border: 1px solid #ccc;"> <p>i NOTE</p> <p>If available, select the HDTV setting (ideally 1080p) from your video card driver's advanced menu. This should provide a pixel-perfect image for your interactive flat panel.</p> </div>
You have a poor quality video cable.		<ol style="list-style-type: none"> 1. Replace your video cable with a better quality video cable. 2. Press the AUTO SET UP button on your remote control to reset your interactive flat panel. <p>OR</p> <p>Select MENU > ADJUST > AUTOSSET on the menu control panel. (For more information, see page 75.)</p>
You connected two video cables together.		<ol style="list-style-type: none"> 1. Replace your two cables with one longer cable. <p>OR</p> <p>Move your computer so that it's within a single cable length of your interactive flat panel.</p> <ol style="list-style-type: none"> 2. Press the AUTO SET UP button on your remote to reset your interactive flat panel. <p>OR</p> <p>Select MENU > ADJUST > AUTO SETUP on the menu control panel. (For more information, see page 75.)</p>

CHAPTER 8

Troubleshooting for your interactive flat panel

Symptom	Causes	Solution
The image isn't centered on the screen.		Press the AUTO SET UP button on the remote control. OR Select MENU > ADJUST > AUTO SET on the menu control panel. (For more information, see page 75.)
The image is unstable or unfocused.	The video connection is loose.	Secure the video cable to both your computer and your interactive flat panel.
	You have a poor quality video cable	1. Replace your video cable with a better quality video cable. 2. Press the AUTO SET UP button on the remote control to reset your interactive flat panel. OR Select MENU > ADJUST > AUTO SETUP on the menu control panel. (For more information, see page 75.)
	You connected two video cables together.	1. Replace your two cables with one longer cable. OR Move your computer so that it's within a single cable length of your interactive flat panel. 2. Press the AUTO SET UP button on your remote to reset your interactive flat panel. OR Select MENU > ADJUST > AUTO SETUP on the menu control panel. (For more information, see page 75.)
	Your computer's video display card is defective.	Connect a different computer to your interactive flat panel. If this improves the image quality, consider replacing the video card in the original computer.
The image is too light, too dark or has poor image quality issues.	You might have incorrect video settings.	Access the on-screen display menu to adjust picture settings, or select MENU > ADVANCED OPTION > FACTORY RESET > YES on the menu control panel. (For more information, see page 75.)

CHAPTER 8



Troubleshooting for your interactive flat panel

Symptom	Causes	Solution
There is a persistent image on the screen.	An image was displayed for too long.	Turn off your interactive flat panel and leave it turned off for as long as the image was on the screen. TIP Use a screen saver to avoid persistent images.
Other display quality issues		Select MENU > ADVANCED OPTION > FACTORY PRESET > YES on the menu control panel. (For more information, see page 75.)

Resolving touch control and digital ink issues



Use the following troubleshooting table if you can see your computer desktop on your interactive flat panel, but you do not have touch control over the desktop.

For more information, see *SMART Ink user's guide for Mac OS X operating system software* (smarttech.com/kb/170192) or *SMART Ink user's guide for Windows operating system* (smarttech.com/kb/170191).

Symptom	Causes	Solution
When you touch the screen, no pointer appears and you can't move icons. The status light is red.	The SMART Product Drivers on your computer are not current.	Update your SMART Product Drivers (see <i>Updating SMART Product Drivers</i> on page 55).
	No USB connection from the computer to the interactive flat panel.	Verify your connections (see page 18).
	Your USB connection doesn't correspond with the selected video input.	Connect the USB to the correct receptacle that corresponds to your computer's video input. (For more information, see page 18.)
The SMART Meeting Pro icon  or the SMART Notebook icon  doesn't appear.	SMART Product Drivers isn't installed.	Download and install SMART software from smarttech.com/downloads . OR Connect your computer or laptop to your interactive flat panel with a SMART GoWire cable. (For more information, see page 50.)

CHAPTER 8

Troubleshooting for your interactive flat panel

Symptom	Causes	Solution
	SMART software isn't running.	Open the SMART Product Drivers folder in your list of programs, and then select SMART Board Tools .
The SMART Board icon  or SMART Meeting Pro icon  is crossed out in red.	Your computer can't find your interactive flat panel.	Start SMART software, and then run the SMART Connection Wizard's troubleshooting procedures.
	Either the <i>SMART Board Diagnostics</i> window or <i>SMART Settings</i> is open.	Close the SMART Board Diagnostics window and the SMART Settings panel.
Touch interactivity is slow or sluggish.	Your computer is running too many applications.	Close some open applications.
	Your computer doesn't meet system requirements.	Upgrade your computer or replace it with a more powerful computer.
	You haven't used a USB 2.0 cable to connect your interactive flat panel to your computer.	Use a USB 2.0 cable and ensure it is connected to a USB 2.0 receptacle on your computer.
When you touch the screen the pointer appears in the wrong location.	You aren't touching the screen at right angles.	For more information, see <i>Touching and drawing on your SMART Board interactive whiteboard is Inaccurate</i> (smarttech.com/kb/131299).
	Your interactive flat panel isn't oriented.	Orient your interactive flat panel. Press the orient button  on the color select module, and then follow the on-screen instructions. (For more information, see page 57.)

CHAPTER 8

Troubleshooting for your interactive flat panel

Symptom	Causes	Solution
	Your desktop isn't centered on the screen.	Press the AUTO SET UP button on your remote control to reset your interactive flat panel. OR Select MENU > ADJUST > AUTO SETUP on the menu control panel. (For more information, see page 75.)  IMPORTANT You might have to do this more than once.
An area of the screen doesn't respond to your touch or when you draw digital ink, the lines are broken.	Something is blocking the cameras.	Ensure nothing is taped to the screen.
	Something is on the reflective tape channel.	Remove items from the reflective tape channel.
	Your finger or pen is skipping as you draw. This is most common on the upstroke.	Use consistent pressure while drawing digital ink.
	Bright lights are interfering with the cameras.	Close blinds or shades or dim all halogen lights and LEDs.
	Your cameras require calibration, possibly due to temperature change in the room.	Calibrate your interactive flat panel. (See page 56.)
You try to erase using something other than the eraser, but you draw more digital ink. One of the color select button lights is flashing.	You're in Locked Ink mode and all objects are interpreted as pens.	Press a color select button that isn't flashing to exit Locked Ink mode. OR Remove the eraser from the eraser holder to enable erasing while in Locked Ink mode.
You try to erase with the eraser, but you draw more digital ink. You don't see a flashing light on the color select module.	You're using an edge of the eraser.	Increase the contact area of your eraser.

CHAPTER 8

Troubleshooting for your interactive flat panel

Symptom	Causes	Solution
You're trying to draw digital ink, but you see a circle beneath your pointer and you're erasing digital ink.	Your interactive flat panel is interpreting an eraser.	Lift other fingers and the heel of your hand from the interactive flat panel while you write because the interactive flat panel is interpreting them as an eraser. OR Use a smaller pointer, such as the pen.

Resolving audio issues

IMPORTANT

Ensure you can see your computer's desktop and have touch control and digital ink before using this table. If not, resolve those issues before completing the following steps in the table below.

Symptom	Causes	Solution
Sound doesn't play when you play a sound file.	Your computer is muted.	Turn off the mute setting.
	Your computer's volume is too low.	Turn up the volume on your computer.
	Your interactive flat panel is muted.	Turn off the mute setting using the remote control or the front control panel.
	Your interactive flat panel's volume is too low.	Use the remote control to turn up the volume on your interactive flat panel. OR Use the volume control on the front control panel.
	The wrong audio input is selected for the video input.	Select the correct audio input. Press AUDIO INPUT on the remote control.
Your computer uses Mac OS X operating system software and is not set to Audio USB output.	Set your computer's audio output to USB. (For more information, see page 46.)	

Resolving remote control issues

Your remote control provides control of your interactive flat panel up to 23' (7 m) from the front control panel of your interactive flat panel.

Symptom	Causes	Solution
The remote control behaves unexpectedly. The front control panel power button light is off.	Your interactive flat panel isn't receiving power.	Ensure your interactive flat panel is plugged in and that the power switch on the bottom terminal panel is in the ON position. (For more information, see page 7.)
	You are outside the range of the infrared remote control sensor.	Move to within 23' (7 m) and a 30° arc of your infrared remote control sensor.
	The remote control batteries need to be replaced.	Replace the batteries. (For more information, see page 31.)
	The remote control is damaged.	Contact your authorized SMART reseller (smarttech.com/where) to inquire about a replacement remote control.
	Something is plugged into the wired remote control receptacles on the audio connection panel, disabling the remote control.	Unplug the connector from the wired remote control receptacles. (For more information, see page 16.)

Resolving issues using the SMART Connection Wizard

You can resolve a variety of issues using the SMART Connection Wizard found in SMART Settings.

■ To start the SMART Connection Wizard

1. Press the **Help** button on the color select module.

The *Help and Support for Your SMART Board Interactive Whiteboard* window opens.

2. Press **Connection Wizard**.

The *SMART Connection Wizard* opens.

NOTE

You can also access the SMART Connection Wizard by pressing the **SMART Board** icon  in the notification area (Windows operating systems) or the Dock (Mac OS X operating system software), and then selecting **SMART Settings > Connection Wizard**.

OR

Click the **SMART Meeting Pro** icon  in the notification area, then select **SMART Settings > Connection Wizard**.

3. Select **SMART Board 8000 series interactive flat panel**, and then press **Next**.
4. Select the option that best describes the issue you're encountering, and follow the on-screen instructions to troubleshoot your interactive flat panel.

Resolving issues using SMART Board Diagnostics

If you touch the interactive flat panel's surface and nothing happens, or if there is no digital ink or the ink appears in some locations and not in others, use SMART Board Diagnostics to help identify and resolve these issues.

IMPORTANT

Do not change diagnostic settings unless asked to do so by SMART Support.

Checking the camera view

If nothing happens when you touch the interactive flat panel's surface, check to make sure that nothing is blocking one of the cameras.

To check camera views

1. Press the **SMART Board** icon  in the notification area (Windows operating systems) or the Dock (Mac OS X operating system software).

OR

Press the **SMART Meeting Pro** icon  in the notification area.
2. Press **SMART Settings**.
SMART Settings opens.
3. Select **About Software and Product Support > Tools > Diagnostics**.
SMART Board Diagnostics opens.
4. In the *View* menu, select **SBX800/SBID8070i/SBID8055i Bar**.
The SBX800 group box appears in the *SMART Board Diagnostics* screen.
5. Press **View**.
The camera view screen appears.
6. Click **Update** to display the four camera views. This could take a few moments.
If one of the camera views remains black, the camera is blocked or can't locate the reflective tape on the interactive flat panel's inner frame.
7. Check the camera lens and ensure that nothing is blocking its view and that nothing is affixed to the interactive surface.

Appendix A

Adjusting video settings with the on-screen display menu

Changing settings in the OSD menu	75
Main menu settings	76
Picture settings	76
Adjustment settings	77
Audio settings	77
Schedule settings	78
PIP (Picture in Picture) settings	78
OSD settings	78
Multi-display settings	79
Display protection settings	80
Advanced option settings	81

You can access the on-screen display (OSD) menu using either the remote control (see *Infrared remote control buttons* on page 33) or the menu control panel on the left side of the interactive flat panel (see *Left side view* on page 6).

Changing settings in the OSD menu

NOTE

You can adjust many of the interactive flat panel screen settings using the remote control.

To change settings in the OSD menu

1. Press the **MENU** button on the menu control panel or the remote control.
The on-screen menu appears.
2. Press the left and right arrows to select a menu.
3. Press **SET**.

APPENDIX A

Adjusting video settings with the on-screen display menu

4. Press the up and down arrows to select the setting you want to change.
5. Press **SET**.
6. Press the left arrow to decrease or the right arrow to increase the value.
OR
Press the up arrow or down arrow to select a value.
7. Press **SET**.
8. To change another setting in the menu, press the **MENU** button and then repeat steps 2–4.
9. When you finish changing settings, press the **MENU** button twice to close the on-screen display menu.

Main menu settings

Picture settings

Menu item	Function
BRIGHTNESS	Adjusts the overall brightness of the image and background. i NOTE You can't change this setting when picture mode is set to AMBIENT1 or AMBIENT2 .
CONTRAST	Adjusts the brightness of the image in relation to the background. The sRGB picture mode is standard and cannot be changed.
SHARPNESS	Adjusts the sharpness of the image.
BLACK LEVEL	Adjusts the brightness of the image in relation to the background. The sRGB picture mode is standard and cannot be changed.
TINT	Adjusts the tint of the screen.
COLOR	Adjusts the color depth of the screen.
COLOR TEMPERATURE	Adjusts the color temperature of the entire screen. The sRGB picture mode is standard and cannot be changed.
COLOR CONTROL	Adjusts the levels of red, yellow, green, cyan, blue, magenta and saturation. The sRGB picture mode is standard and cannot be changed.
GAMMA SELECTION	Selects a display gamma for best picture quality. The sRGB picture mode is standard and cannot be changed.
MOVIE SETTING	Sets NOISE REDUCTION, FILM MODE and ADAPTIVE CONTRAST.

APPENDIX A

Adjusting video settings with the on-screen display menu

Menu item	Function
PICTURE MODE	Sets picture mode to HIGHBRIGHT, STANDARD, sRGB, CINEMA, AMBIENT1 or AMBIENT2.
PICTURE RESET	Restores the picture settings to their default values.

Adjustment settings

Menu item	Function
AUTO SETUP	Adjusts Screen Size, H position, V position, Clock, Clock Phase and White Level automatically.
AUTO ADJUST	Sets H Position, V Position and Clock Phase to adjust automatically when your interactive flat panel is turned on.
H POSITION	Controls the horizontal position of the image within the screen area.
V POSITION	Controls the vertical position of the image within the screen area.
CLOCK	Adjusts the width of the image.
CLOCK PHASE	Adjusts the visual noise on the image.
H RESOLUTION	Adjusts the horizontal size of the image.
V RESOLUTION	Adjusts the vertical size of the image.
INPUT RESOLUTION	Displays the signal at the desired resolution. After selecting this, use the AUTO SETUP option above.
ZOOM MODE	Selects the aspect ratio of the screen image.
ASPECT	Sets picture aspect to FULL, NORMAL, TRIM or ZOOM.
ADJUST RESET	Restores the adjustment settings to their default values.

Audio settings

Menu item	Function
BALANCE	Adjust the balance of left and right volume.
TREBLE	Adjusts the high frequency sound.
BASS	Adjusts the low frequency sound.
PIP AUDIO	Selects the sound source when in Picture in Picture mode.
LINE OUT	Selects FIXED or VARIABLE audio line out.
SURROUND	Sets artificial surround sound.
AUDIO INPUT	Sets audio input source to IN1, IN2, IN3, HDMI or TV.
AUDIO RESET	Restores the audio settings to their default values.

APPENDIX A

Adjusting video settings with the on-screen display menu

Schedule settings

Menu item	Function
OFF TIMER	Sets the time from the last input to when the interactive flat panel automatically turns off. You can set this from 1–24 hours.
SCHEDULE SETTING	Creates a schedule for the interactive flat panel to use.  IMPORTANT You must set the date and time values before you can set a schedule.
SCHEDULE LIST	Displays the interactive flat panel's schedules.
DATE & TIME	Sets the date, time, time zone and daylight savings time.
SCHEDULE RESET	Restores the schedule settings to their default values.

PIP (Picture in Picture) settings

Menu item	Function
KEEP PIP MODE	Enables the interactive flat panel to remain in PIP and TEXT TICKER modes after it's turned off and turned on again.
PIP MODE	Sets the sub-picture mode to PIP, POP, SBS aspect or SBS full.
PIP SIZE	Selects the size of the sub-picture used in PIP mode.
PIP POSITION	Determines where the PIP appears on the screen.
ASPECT	Selects sub-picture aspect. Options are FULL, NORMAL, WIDE and ZOOM.
TEXT TICKER	Allows text insertion in main screen with the ability to adjust.
SUB INPUT	Selects sub-picture input signal.
PIP RESET	Restores the PIP settings to their default values.

OSD settings



Menu item	Function
LANGUAGE	Selects the language used by the OSD menu.
OSD TURN OFF	Turns off the OSD menu after a period of inactivity. The preset choices are 10–240 seconds.
OSD POSITION	Sets where the OSD menu appears on the screen to Left or Right.
INFORMATION OSD	Selects if the Information OSD menu is displayed.
MONITOR INFORMATION	Displays interactive flat panel information.

APPENDIX A

Adjusting video settings with the on-screen display menu

Menu item	Function
CARBON SAVINGS	Displays the estimated carbon saving information in kilograms.
OSD TRANSPARENCY	Sets the transparency level of the OSD menu.
OSD ROTATION	Sets the OSD menu display direction to landscape or portrait.
INPUT NAME	Sets INPUT name. Maximum length is 8 letters, and you can use spaces, letters from A-Z, numerals from 0-9 and some symbols.
CLOSED CAPTION	Activates closed captioning.
OSD RESET	Restores the OSD settings to their default values.

Multi-display settings

Menu item	Function
MONITOR ID	Sets the monitor ID number from 1 to 100 and the group ID from A to J.
IR CONTROL	Selects the mode of the interactive flat panel for use with the remote control when using the RS-232C daisy chain.
TILING	Allows an image to be expanded and displayed on multiple monitors (up to 100) through a distribution amplifier. <div data-bbox="662 995 1471 1094"><p> NOTE Use a high resolution when tiling an image to multiple monitors.</p></div>
POWER ON DELAY	Adjusts the delay time between being in Standby mode and entering Power on mode. The POWER ON DELAY can be set between 0 and 50 seconds.
POWER INDICATOR	Turns on or off the power indicator light. If you select OFF, the power indicator light doesn't turn on when the interactive flat panel is in Active mode.
EXTERNAL CONTROL	Sets the control interface to RS-232C or LAN.
SETTING COPY	Sets the OSD menu categories that copy from the current monitor to additional monitors that are connected in a daisy-chain configuration. Setting copy settings reset to default when the interactive flat panel is turned off. <div data-bbox="662 1549 1471 1707"><p> IMPORTANT</p><ul style="list-style-type: none">• Set EXTERNAL CONTROL to RS-232C to use this function.• This function is limited to five additional monitors.</div>
MULTI DISPLAY RESET	Restores the multi-display settings to their default values.

APPENDIX A

Adjusting video settings with the on-screen display menu

Display protection settings

Menu item	Function
POWER SAVE	Sets how long the interactive flat panel waits to go into Power Save mode after a lost signal. i NOTE When you connect a DVI video cable, the video card might not stop sending digital data even if there is no image. In this case the interactive flat panel doesn't enter Power Save mode.
STANDBY MODE	Lowers power consumption. i NOTE You can't use RS-232C and LAN Functions in Eco Standby mode.
HEAT STATUS	Displays the FAN, BRIGHTNESS and TEMPERATURE settings.
FAN CONTROL	Sets the cooling fan to protect the interactive flat panel from overheating. When it's selected, you can adjust the starting temperature of the cooling fan and its speed.
SCREEN SAVER	Sets a screen saver to reduce the risk of a persistent image.
SIDE BORDER COLOR	Adjusts the color of the borders that appear when a 4:3 image is displayed.
AUTO BRIGHTNESS	Adjusts the brightness level according to the input signal. i NOTE You can't select this function when the picture mode is set to AMBIENT1 or AMBIENT2.
CHANGE SECURITY PASSWORD	Enables you to change the security password. The preset password is 0000.
SECURITY LOCK	Locks the security password.
DDC CI	ENABLE/DISABLE: turns on or off the two-way communication and control of the interactive flat panel.
DISPLAY PROTECTION RESET	Restores the Display Protection settings to their default values.

APPENDIX A

Adjusting video settings with the on-screen display menu

Advanced option settings

Menu item	Function
INPUT DETECT	Selects the method of input detection the interactive flat panel uses when more than two input devices are connected.
INPUT CHANGE	Sets input change speed. i NOTE When QUICK is selected, the image might be distorted when the input signal changes.
LONG CABLE COMP	Manually compensates for image degradation caused from using a long cable.
TERMINAL SETTING	Sets DVI MODE, BNC MODE, SCART MODE and HDMI SIGNAL.
SCAN CONVERSION	Selects the IP (Interlace to Progressive) conversion function. i NOTE For DVI inputs, set the DVI MODE menu to DVI-HD.
COLOR SYSTEM	Sets the color system, depending on the video format of the input signal.
SCAN MODE	Sets the scanning mode. Some video formats might require different modes to display the best image.
ADVANCED OPTION RESET	Restores the advanced option settings to their default values.
FACTORY RESET	Restores OSD options to default values for all items, except for DATE & TIME, LANGUAGE, OSD ROTATION, INPUT NAME, CHANGE SECURITY PASSWORD, SECURITY LOCK and SECURITY PASSWORD.

Appendix B

Hardware environmental compliance

SMART Technologies supports global efforts to ensure that electronic equipment is manufactured, sold and disposed of in a safe and environmentally friendly manner.

Waste Electrical and Electronic Equipment regulations (WEEE directive)

Electrical and electronic equipment and batteries contain substances that can be harmful to the environment and to human health. The crossed-out wheeled bin symbol indicates that products should be disposed of in the appropriate recycling stream and not as regular waste.

Restriction of Certain Hazardous Substances (RoHS directive)

This product meets the requirements of the European Union's Restriction of Certain Hazardous Substances (RoHS) directive 2011/65/EU.

Consequently, this product also complies with other regulations that have arisen in various geographical areas, and that reference the European Union's RoHS directive.

Batteries

The remote contains a CR 2025 lithium battery. Recycle or dispose of batteries properly.

Perchlorate Material

Contains perchlorate material. Special handling may apply. See dtsc.ca.gov/hazardouswaste/perchlorate.

APPENDIX B

Hardware environmental compliance

Packaging

Many countries have regulations restricting the use of certain heavy metals in product packaging. The packaging used by SMART Technologies to ship products complies with applicable packaging laws.

China's Electronic Information Products regulations

China regulates products that are classified as EIP (Electronic Information Products).

SMART Technologies products fall under this classification and meet the requirements for China's EIP regulations.

Index

A

- Adjust settings See also Adjustment settings
- Adjustment settings 77
- Advanced option settings 81
- audio files
 - playing 46
- Audio settings 77
- audio terminal panel 9
 - speaker wire connections 9
 - wired remote control receptacles 9

B

- batteries 83
- bottom terminal panel
 - connecting a peripheral device 23
 - connections 8
 - guest laptop video input 21
 - room computer video input 19

C

- calibration 56
- Chinese regulations 84
- cleaning
 - camera windows 58
 - reflective tape 58
 - screen 58
- condensation 59
- connection
 - guest laptop 49
 - peripheral devices 23
 - room computer 19
 - room control system 17

D

- digital ink
 - drawing 36
 - erasing 38
 - writing 36
- disabling
 - USB receptacle 22
- Display protection settings 80
- double-clicking 40

E

- EIP regulations 84
- European Union regulations 83

G

- gestures
 - next page 43
 - panning 46
 - previous page 44
 - resizing 42
 - rotating 43
 - zooming in and out 45
- GoWire See SMART GoWire cable

H

- HDMI connections 8

I

- Ink See SMART Ink
- Ink Aware See SMART Ink

INDEX

- inside terminal panel
 - connections 8
 - guest laptop USB input 21
 - room computer USB input 19
 - room control system 17
- installation
 - choosing a location 13
 - choosing a mounting height 14
 - guest laptop connection 20
 - important information 12
 - SMART Notebook software 26
 - SMARTMeeting Pro software 26
 - speakers 16
- interactive flat panel
 - about 2
 - indicators and controls of 5
 - maintaining 53
 - using 29

L

- laptop
 - guest laptop connection 20
 - side laptop connection 51
- left-clicking 39

M

- Mac OS X USB audio output 46
- menu control panel 6
- Multi-display settings 79

O

- objects
 - resizing 42
 - rotating 43
- on-screen display See OSD
- on-screen display menu settings See OSD Settings
- orientation
 - about 57

- OSD
 - changing settings 75
- OSD settings 78

P

- packaging 84
- panning 46
- pen nib
 - replacing 57
- Picture in Picture settings 78
- Picture settings 76
- PIP settings See Picture in Picture settings

R

- remote control
 - about 31
 - buttons 33
 - installing batteries 31
 - sensor 32
 - wired remote control receptacles 9
- right-clicking 40
- RoHS directive 83

S

- Schedule settings 78
- side terminal panel 6
- SMART Board interactive flat panels 35
- SMART GoWire cable 50
- SMART Ink 35
- SMART Ink Document Viewer 35
- SMART Ink Toolbar 35
- speaker wire connections 9, 16
- speakers
 - install 16

U

- updating
 - interactive flat panel firmware 54

INDEX

SMART Product Drivers 55

SMART software 53

USB receptacle

 disable 22

V

video connections 18

W

WEEE directive 83

wired remote control receptacles 9

Z

zoom 45

SMART Technologies

smarttech.com/support

smarttech.com/contactsupport