

ClickShare

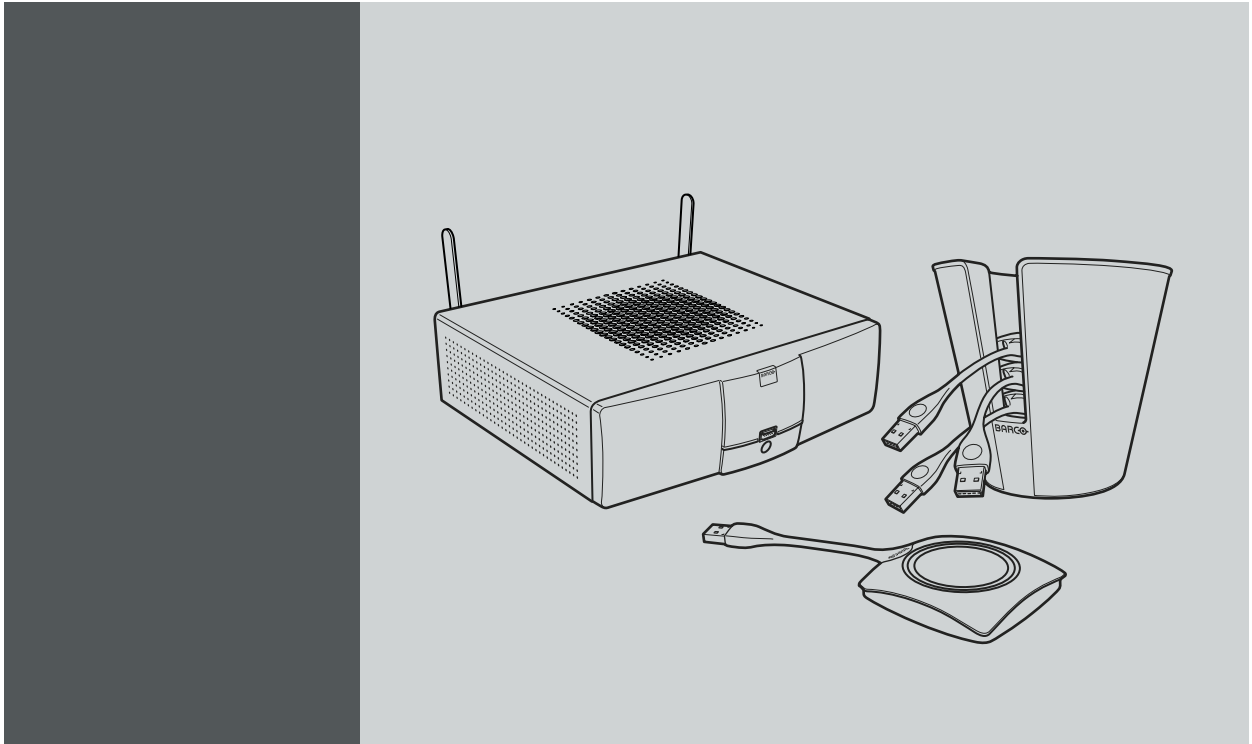

## User Guide

**Barco nv**  
President Kennedypark 35, 8500 Kortrijk, Belgium  
Phone: +32 56.23.32.11  
Fax: +32 56.26.22.62  
Support: [www.barco.com/esupport](http://www.barco.com/esupport)  
Visit us at the web: [www.barco.com](http://www.barco.com)

Printed in China

## Changes

Barco provides this manual 'as is' without warranty of any kind, either expressed or implied, including but not limited to the implied warranties or merchantability and fitness for a particular purpose. Barco may make improvements and/or changes to the product(s) and/or the program(s) described in this publication at any time without notice.

This publication could contain technical inaccuracies or typographical errors. Changes are periodically made to the information in this publication; these changes are incorporated in new editions of this publication.

The latest edition of Barco manuals can be downloaded from the Barco web site [www.barco.com](http://www.barco.com) or from the secured Barco web site <https://my.barco.com>.

## Copyright ©

All rights reserved. No part of this document may be copied, reproduced or translated. It shall not otherwise be recorded, transmitted or stored in a retrieval system without the prior written consent of Barco.

## Barco ClickShare End-User License Agreement (EULA)

PLEASE READ THIS DOCUMENT CAREFULLY BEFORE OPENING OR DOWNLOADING AND USING SOFTWARE OR HARDWARE PROVIDED TO YOU BY BARCO AS IT CONTAINS THE TERMS AND CONDITIONS BY WHICH BARCO OFFERS TO LICENSE THE SOFTWARE. BY OPENING THE SOFTWARE PACKAGE, OR USING THE HARDWARE IN WHICH THE SOFTWARE IS EMBEDDED, YOU AGREE TO BECOME BOUND BY THE TERMS OF THIS AGREEMENT.

The Software as supplied by BARCO is licensed, not sold to you, on a non-exclusive basis for use only under the terms of this license, and BARCO reserve all rights not expressly granted to you. You own the disk(s) on which the Software is provided, but the Software is owned and copyrighted by BARCO or by third party suppliers. Your license confers no title or ownership and is not a sale of any rights in the Software or its documentation.

By installing, executing and/or using the Software, either as initial version or as an upgrade, update, patch or enhancement of a prior release, this Software License shall supersede any terms and conditions previously agreed upon (whether or not in writing) between Barco and you with respect to the subject matter of this Software License and such previous terms shall from the date hereof cease to have any force or effect; provided, however that this Software License shall not be construed as a renunciation, discharge or waiver of any right or remedy provided in any terms and conditions previously agreed upon with respect to a failure of either party to perform any of its obligations under any terms and conditions previously agreed upon.

### Software Specifications

The Software contains the following product: ClickShare (Base Unit, Button and client software).

### Software License Terms

1. This Software License is between you and BARCO NV, a corporation organized and existing under the laws of Belgium registered under number BE 0473.191.041, Commercial Companies' Register of Kortrijk, having its registered office President Kennedypark, 35 at B-8500 Kortrijk, Belgium ("Barco") for the use of the Software.  
You hereby undertake to inform all Authorized Users of the terms of this Software License and to bind all Authorized Users to accept all such terms of this Software License as applies to them. Barco grants you a limited, non-exclusive, non-assignable, non-transferable license (without the right to grant sublicenses).
2. The Software component parts must not be separated, replicated or reverse engineered in any manner. You and Authorized Users are entitled to use the Software for the purposes and in the manner set out in this EULA (and documentation), but neither you nor any Authorized User are entitled to: (i) sell or grant a security interest in the Software to other parties in any way, or to rent, lease or sub-license the Software to others without the express prior written consent of Barco; or (ii) exploit the Software or any of its component parts for any commercial purpose, other than use by you and/or Authorized Users of the Software.

3. Barco shall hold you harmless and indemnify you from and against direct damages, losses and expenses arising from infringement or alleged infringement of any patent, trademark or copyright of such third party by the license and the right to install the Software as permitted by this Software License and defend and settle at its sole expense any claim, action, suit or proceeding brought against you, provided that (i) you promptly notify Barco in writing after a claim has been asserted against you or the commencement of any claim, action, suit or proceeding, and (ii) Barco shall assume sole control of the defense and any settlement negotiations related to any claim, action, suit or proceeding, and (iii) you shall not negotiate, settle or compromise any claim, action, suit or proceeding without the prior written consent of Barco and (iv) you, at your cost, shall cooperate with Barco and provide assistance and support, as may reasonably be required by Barco, in connection with the defense and any settlement negotiations related to any claim, action, suit or proceeding. Barco shall have no indemnity obligation for any Software, or any portion thereof, (i) that is based on specifications, drawings, models or other data furnished by you or, (ii) that is not provided by Barco or, (iii) that is modified, in spite of the prohibition for you to modify the software or, (iv) to the extent that you continue allegedly infringing activity after having been provided modifications that avoid the alleged infringement, or (v) where the use of the Software, or the combination or thereof with other Software, processes or materials or the distribution thereof rather than the Software itself is the primary cause of an alleged infringement. In case it has been determined by a finally awarded judgment that Barco infringed or misappropriated such third party rights or earlier, at Barco's discretion, it may, at its option and cost, (i) modify the Software in such a way that it shall not infringe upon or misappropriate the rights of the third party or (ii) obtain for you a license or other right to use the rights allegedly infringed or (iii) replace the Software in question with non-infringing Software. The remedies set forth in this paragraph shall constitute your sole and exclusive remedy and Barco's sole and exclusive liability for a third party claim that the Product infringes or misappropriates any intellectual property right of a third party.
4. Barco (and Barco's licensors, as appropriate) retain ownership of all intellectual property rights in the Software and any copies you or any Authorized User may make of such Software. The Software is protected by national copyright laws, international copyright treaties and conventions, and other applicable laws. All rights not expressly licensed to you in this Software License are reserved to Barco and Barco's licensors, as appropriate. The Software contains certain other licensed materials and Barco's licensors may protect their rights in the event of any violation of this Software License. Neither you nor any Authorized User may, whether in whole or in part, copy, translate, reverse engineer, derive source code from, modify, disassemble, decompile, create derivative works based on the Software, or remove any proprietary notices or labels on the Software, save as may be permitted by law or this Software License, without the prior consent, in writing, of Barco.
5. The duration of this Software License will be from the date of your acceptance (as set forth above) of the Software (whereby you acknowledge that use of the Software implies acceptance), with no termination date, unless otherwise specified. You may terminate this Software License at any time by destroying all copies of the Software then in your possession and returning all associated materials and documentation, to Barco or the appointed Barco reseller that sold or provided these to you. Barco may terminate this Software License forthwith by informing you at any time if you and/or any Authorized User are in breach of any of the Software License's terms.
6. YOU UNDERSTAND THAT THE SOFTWARE IS BEING PROVIDED TO YOU "AS IS". BARCO DOES NOT MAKE NOR INTENDS TO MAKE ANY WARRANTIES OR REPRESENTATIONS, EXPRESS OR IMPLIED AND SPECIFICALLY DISCLAIMS ALL IMPLIED WARRANTIES OF MERCHANTABILITY FITNESS, FOR A PARTICULAR PURPOSE AND NON-INFRINGEMENT OF INTELLECTUAL PROPERTY AND DOES NOT WARRANT THAT THE SOFTWARE WILL BE FREE FROM ERRORS OR THAT SUCH ERRORS WILL BE CORRECTED BY BARCO AND YOU ARE SOLELY RESPONSIBLE FOR ALL COSTS AND EXPENSES ASSOCIATED WITH RECTIFICATION, REPAIR OR DAMAGE CAUSED BY SUCH ERRORS.  
**YOU ALSO ACKNOWLEDGE AND AGREE THAT:**  
BARCO ACCEPTS NO LIABILITY FOR ANY DAMAGES, LOSSES OR CLAIMS YOU OR ANY THIRD PARTY MAY SUFFER AS A RESULT OF YOUR USE OF THE SOFTWARE, AND YOU HEREBY AGREE TO INDEMNIFY, KEEP INDEMNIFIED, DEFEND AND HOLD HARMLESS BARCO AND BARCO'S AFFILIATES AND SUBSIDIARIES FROM AND AGAINST ANY AND ALL ACTIONS, PROCEEDINGS, LIABILITY, LOSS, DAMAGES, FEES AND COSTS (INCLUDING ATTORNEYS' FEES), AND OTHER EXPENSES INCURRED OR SUFFERED BY BARCO ARISING OUT OF OR IN CONNECTION WITH ANY BREACH BY YOU OF THE TERMS OF THIS SOFTWARE LICENSE. TO THE MAXIMUM EXTENT PERMITTED BY LAW, IN NO EVENT WILL BARCO BE LIABLE FOR ANY INDIRECT, SPECIAL, PUNITIVE, INCIDENTAL OR CONSEQUENTIAL LOSS OR DAMAGES OF ANY KIND WHICH MAY ARISE OUT OF OR IN CONNECTION WITH THE SOFTWARE, THIS SOFTWARE LICENSE OR THE PERFORMANCE OR PURPORTED PERFORMANCE OF OR FAILURE IN THE PERFORMANCE OF BARCO'S OBLIGATIONS UNDER THIS SOFTWARE LICENSE OR FOR ANY ECONOMIC LOSS, LOSS OF BUSINESS, CONTRACTS, DATA, GOODWILL, PROFITS, TURNOVER, REVENUE, REPUTATION OR ANY LOSS ARISING FROM WORK STOPPAGE, COMPUTER FAILURE OR MALFUNCTION OF THE SOFTWARE AND ANY AND ALL OTHER COMMERCIAL DAMAGES OR LOSSES WHICH MAY ARISE IN RESPECT OF USE OF THE SOFTWARE, EVEN IF BARCO HAS BEEN ADVISED OF THE POSSIBILITY OF THEIR OCCURRENCE; AND
7. You shall treat as confidential all information obtained from the other pursuant to this Software License which is marked 'confidential' or the equivalent or has the necessary quality of confidence about it and shall not divulge such information to any persons without Barco's prior written consent provided that this Paragraph 7 shall not extend to information which was rightfully in the possession of you prior to the commencement of the negotiations leading to this Software License, which is already public knowledge or becomes so at a future date (otherwise than as a result of a breach of this paragraph 7), is required to be disclosed by law or which is trivial or obvious. You are aware of and ensure to comply with the provisions of this paragraph 7. The foregoing obligations as to confidentiality shall survive any termination of this Software License.
8. You agree with and fully accept the following limited service and support statements.  
You will remain responsible for the maintenance of your hardware, operating system, the functioning of your network and in keeping your systems virus-free. You acknowledge that the Software is a complex computer software application, and that the performance thereof may vary depending hardware platform, software interactions and configuration. You acknowledge that the Software is not designed and produced specifically to meet your specific requirements and expectations and the selection of the Software by you is entirely your own choice and decision.  
For the avoidance of doubt, nothing in this clause shall impose any obligation on Barco to provide Support Services.

9. This Software License is the only understanding and agreement between you and Barco for use of the Software by you and/or Authorized Users. The Software License supersedes all other communications, understandings or agreements we had prior to this Software License (with the exception of any continuing confidentiality agreement) although nothing in this Software License purports to exclude liability for fraudulent misrepresentation. You may not export or re-export the Software or any copy or adaptation in violation of any applicable laws or regulations. This Software License shall not be altered, amended or varied. If any provision of this Software License is determined to be illegal, void or unenforceable, or if any court of competent jurisdiction in any final decision so determines, this Software License shall continue in full force save that such provision shall be deemed to be deleted with effect from the date of such decision, or such earlier date.
10. You acknowledge that this Software may be subject to U.S. or other governments Export Jurisdiction. You agree to comply with all applicable international and national laws that apply to the Software, including the U.S. Export Administration Regulations, as well as end-user, end-use, and destination restrictions issued by the U.S. or other governments.
11. Barco shall be entitled to sub-contract all or any of Barco's obligations hereunder to a third party and/or any of Barco's affiliated companies.
12. The construction, validity and performance of this Software License shall be governed in all respects by the laws of Belgium without recourse to its conflict of law principles. All disputes arising in any way out of or affecting this Software License shall be subject to the exclusive jurisdiction of the courts of Kortrijk, without prejudice to enforcement of any judgment or order thereof in any other jurisdiction.
13. The United Nations Convention on Contracts for the International Sale of Goods (the "Convention") shall not apply to this Software License, however, if the Convention is deemed by a court of competent jurisdiction to apply to this Software License, Barco shall not be liable for any claimed non-conformance of the Software under Article 35(2) of the Convention.

#### Trademarks Software License Terms

Brand and product names mentioned in this manual may be trademarks, registered trademarks or copyrights of their respective holders. All brand and product names mentioned in this manual serve as comments or examples and are not to be understood as advertising for the products or their manufacturers.

#### Open Source Software provisions:

EACH SEPARATE OPEN SOURCE SOFTWARE COMPONENT AND ANY RELATED DOCUMENTATION ARE PROVIDED "AS IS" WITHOUT EXPRESS OR IMPLIED WARRANTY INCLUDING, BUT NOT LIMITED TO, THE IMPLIED WARRANTIES OF MERCHANTABILITY AND FITNESS FOR A PARTICULAR PURPOSE. IN NO EVENT SHALL THE COPYRIGHTHOLDER OR ANY OTHER CONTRIBUTOR BE LIABLE FOR DIRECT, INCIDENTAL OR CONSEQUENTIAL DAMAGES, EVEN IF ADVISED OF THE POSSIBILITY OF SUCH DAMAGES. MORE INFORMATION /DETAILS IS TO BE FOUND IN EACH SPECIFIC OPEN SOURCE LICENSE.

Copyright on each Open Source Software component belongs to the respective initial copyright holder, each additional contributor and/or their respective assignee(s), as may be identified in the respective documentation, source code, README file, or otherwise. You shall not remove or obscure or otherwise alter the respective copyrights.

You acknowledge living up to the conditions of each separate Open Source Software license.

In the development of the Software, the following Open Source Software components have been used:

Open Source component	Open Source License
alsa-lib	<a href="http://www.gnu.org/licenses/gpl.html">http://www.gnu.org/licenses/gpl.html</a> <a href="http://www.gnu.org/licenses/lgpl.html">http://www.gnu.org/licenses/lgpl.html</a>
alsa-utils	<a href="http://www.gnu.org/licenses/gpl.html">http://www.gnu.org/licenses/gpl.html</a> <a href="http://www.gnu.org/licenses/lgpl.html">http://www.gnu.org/licenses/lgpl.html</a>
busybox	<a href="http://opensource.org/licenses/GPL-2.0">http://opensource.org/licenses/GPL-2.0</a>
dropbear	<a href="http://opensource.org/licenses/mit-license.php">http://opensource.org/licenses/mit-license.php</a>
fakeroot	<a href="http://www.gnu.org/licenses/gpl.html">http://www.gnu.org/licenses/gpl.html</a>
linux	<a href="http://www.gnu.org/licenses/old-licenses/gpl-2.0.html">http://www.gnu.org/licenses/old-licenses/gpl-2.0.html</a>
gmp	<a href="http://www.gnu.org/licenses/lgpl.html">http://www.gnu.org/licenses/lgpl.html</a>
iproute2	<a href="http://www.gnu.org/licenses/gpl.html">http://www.gnu.org/licenses/gpl.html</a>
kobs-ng	<a href="http://www.gnu.org/licenses/gpl.html">http://www.gnu.org/licenses/gpl.html</a>
rsync (<3.0.0)	<a href="http://www.gnu.org/licenses/old-licenses/gpl-2.0.html">http://www.gnu.org/licenses/old-licenses/gpl-2.0.html</a>
rsync (>=3.0.0)	<a href="http://www.gnu.org/licenses/gpl.html">http://www.gnu.org/licenses/gpl.html</a>
uClibc	<a href="http://www.gnu.org/licenses/lgpl.html">http://www.gnu.org/licenses/lgpl.html</a>
wireless_tools	<a href="http://www.gnu.org/licenses/gpl.html">http://www.gnu.org/licenses/gpl.html</a>

Open Source component	Open Source License
wpa_supplicant	<a href="http://opensource.org/licenses/BSD-3-Clause">http://opensource.org/licenses/BSD-3-Clause</a>
imx-bootlets	<a href="http://www.gnu.org/licenses/gpl.html">http://www.gnu.org/licenses/gpl.html</a>
Crypto++	<a href="http://www.cryptopp.com/License.txt">http://www.cryptopp.com/License.txt</a>
libresample	<a href="http://www.gnu.org/licenses/lgpl.html">http://www.gnu.org/licenses/lgpl.html</a>
libjpeg-turbo	<a href="http://opensource.org/licenses/BSD-3-Clause">http://opensource.org/licenses/BSD-3-Clause</a>
acpid	<a href="http://www.gnu.org/licenses/gpl.html">http://www.gnu.org/licenses/gpl.html</a>
avahi	<a href="http://www.gnu.org/licenses/lgpl.html">http://www.gnu.org/licenses/lgpl.html</a>
crda	<a href="http://opensource.org/licenses/ISC">http://opensource.org/licenses/ISC</a>
cron	<a href="http://opensource.org/licenses/ISC">http://opensource.org/licenses/ISC</a>
dbus	<a href="http://www.gnu.org/licenses/old-licenses/gpl-2.0.html">http://www.gnu.org/licenses/old-licenses/gpl-2.0.html</a>
dhcpcd	<a href="http://opensource.org/licenses/ISC">http://opensource.org/licenses/ISC</a>
dmidecode	<a href="http://www.gnu.org/licenses/old-licenses/gpl-2.0.html">http://www.gnu.org/licenses/old-licenses/gpl-2.0.html</a>
e2fsprogs	<a href="http://www.gnu.org/licenses/old-licenses/lgpl-2.1.html">http://www.gnu.org/licenses/old-licenses/lgpl-2.1.html</a>
eglibc	<a href="http://www.gnu.org/licenses/lgpl.html">http://www.gnu.org/licenses/lgpl.html</a>
ethtool	<a href="http://www.gnu.org/licenses/lgpl.html">http://www.gnu.org/licenses/lgpl.html</a>
gdbserver	<a href="http://www.gnu.org/licenses/lgpl.html">http://www.gnu.org/licenses/lgpl.html</a>
grub	<a href="http://www.gnu.org/licenses/lgpl.html">http://www.gnu.org/licenses/lgpl.html</a>
gststreamer	<a href="http://www.gnu.org/licenses/lgpl.html">http://www.gnu.org/licenses/lgpl.html</a>
hdparm	<a href="http://opensource.org/licenses/BSD-3-Clause">http://opensource.org/licenses/BSD-3-Clause</a>
hostapd	<a href="http://opensource.org/licenses/BSD-3-Clause">http://opensource.org/licenses/BSD-3-Clause</a>
i2c-tools	<a href="http://www.gnu.org/licenses/old-licenses/gpl-2.0.html">http://www.gnu.org/licenses/old-licenses/gpl-2.0.html</a>
iftop	<a href="http://www.gnu.org/licenses/old-licenses/gpl-2.0.html">http://www.gnu.org/licenses/old-licenses/gpl-2.0.html</a>
iperf	<a href="http://opensource.org/licenses/BSD-3-Clause">http://opensource.org/licenses/BSD-3-Clause</a>
iptables	<a href="http://www.gnu.org/licenses/old-licenses/gpl-2.0.html">http://www.gnu.org/licenses/old-licenses/gpl-2.0.html</a>
iw	<a href="http://opensource.org/licenses/BSD-3-Clause">http://opensource.org/licenses/BSD-3-Clause</a>
acl	<a href="http://www.gnu.org/licenses/old-licenses/gpl-2.0.html">http://www.gnu.org/licenses/old-licenses/gpl-2.0.html</a>
attr	<a href="http://www.gnu.org/licenses/old-licenses/gpl-2.0.html">http://www.gnu.org/licenses/old-licenses/gpl-2.0.html</a>
libav	<a href="http://www.gnu.org/licenses/old-licenses/lgpl-2.1.html">http://www.gnu.org/licenses/old-licenses/lgpl-2.1.html</a>
libcap2	<a href="http://www.gnu.org/licenses/gpl.html">http://www.gnu.org/licenses/gpl.html</a>
libdaemon0	<a href="http://www.gnu.org/licenses/old-licenses/lgpl-2.1.html">http://www.gnu.org/licenses/old-licenses/lgpl-2.1.html</a>
libdrm2	<a href="http://opensource.org/licenses/MIT">http://opensource.org/licenses/MIT</a>
libexpat1	<a href="http://opensource.org/licenses/MIT">http://opensource.org/licenses/MIT</a>
libfontconfig1	<a href="http://opensource.org/licenses/BSD-3-Clause">http://opensource.org/licenses/BSD-3-Clause</a>
libfontenc1	<a href="http://opensource.org/licenses/BSD-3-Clause">http://opensource.org/licenses/BSD-3-Clause</a>
freetype	<a href="http://freetype.sourceforge.net/FTL.TXT">http://freetype.sourceforge.net/FTL.TXT</a> <a href="http://www.gnu.org/licenses/old-licenses/gpl-2.0.html">http://www.gnu.org/licenses/old-licenses/gpl-2.0.html</a>
libgcc1	<a href="http://www.gnu.org/licenses/gpl.html">http://www.gnu.org/licenses/gpl.html</a>
libcrypt11	<a href="http://www.gnu.org/licenses/gpl.html">http://www.gnu.org/licenses/gpl.html</a> <a href="http://www.gnu.org/licenses/lgpl.html">http://www.gnu.org/licenses/lgpl.html</a> <a href="http://www.gnu.org/copyleft/fdl.html">http://www.gnu.org/copyleft/fdl.html</a>

Open Source component	Open Source License
libglib-2	<a href="http://www.gnu.org/licenses/old-licenses/lgpl-2.1.html">http://www.gnu.org/licenses/old-licenses/lgpl-2.1.html</a>
libgnutls26	<a href="http://www.gnu.org/licenses/lgpl.html">http://www.gnu.org/licenses/lgpl.html</a>
libgpg-error0	<a href="http://www.gnu.org/licenses/gpl.html">http://www.gnu.org/licenses/gpl.html</a> <a href="http://www.gnu.org/licenses/lgpl.html">http://www.gnu.org/licenses/lgpl.html</a> <a href="http://www.gnu.org/copyleft/fdl.html">http://www.gnu.org/copyleft/fdl.html</a>
libjpeg8	BSD like license
libnl2	<a href="http://www.gnu.org/licenses/lgpl.html">http://www.gnu.org/licenses/lgpl.html</a>
libnss-mdns	<a href="http://www.gnu.org/licenses/gpl.html">http://www.gnu.org/licenses/gpl.html</a>
libpam	<a href="http://www.gnu.org/licenses/old-licenses/gpl-2.0.html">http://www.gnu.org/licenses/old-licenses/gpl-2.0.html</a>
libpcap	<a href="http://opensource.org/licenses/BSD-3-Clause">http://opensource.org/licenses/BSD-3-Clause</a>
libpcre0	<a href="http://opensource.org/licenses/BSD-3-Clause">http://opensource.org/licenses/BSD-3-Clause</a>
libpixman-1-0	<a href="http://changelogs.ubuntu.com/changelogs/pool/main/p/pixman/pixman_0.10.0-0ubuntu1/libpixman-1-0.copyright">http://changelogs.ubuntu.com/changelogs/pool/main/p/pixman/pixman_0.10.0-0ubuntu1/libpixman-1-0.copyright</a>
libpng12-0	<a href="http://www.libpng.org/pub/png/src/libpng-LICENSE.txt">http://www.libpng.org/pub/png/src/libpng-LICENSE.txt</a>
libpopt0	<a href="http://opensource.org/licenses/MIT">http://opensource.org/licenses/MIT</a>
libsm6	
libstdc++6	<a href="http://www.gnu.org/licenses/gpl.html">http://www.gnu.org/licenses/gpl.html</a>
libtalloc2	<a href="http://www.gnu.org/licenses/lgpl.html">http://www.gnu.org/licenses/lgpl.html</a>
libusb	<a href="http://www.gnu.org/licenses/old-licenses/lgpl-2.1.html">http://www.gnu.org/licenses/old-licenses/lgpl-2.1.html</a>
libxml2	<a href="http://opensource.org/licenses/MIT">http://opensource.org/licenses/MIT</a>
libz1	Free license
lighttpd	<a href="http://opensource.org/licenses/BSD-3-Clause">http://opensource.org/licenses/BSD-3-Clause</a>
lmsensors	<a href="http://www.gnu.org/licenses/gpl.html">http://www.gnu.org/licenses/gpl.html</a>
logrotate	<a href="http://www.gnu.org/licenses/gpl.html">http://www.gnu.org/licenses/gpl.html</a>
makedevs	<a href="http://www.gnu.org/licenses/gpl.html">http://www.gnu.org/licenses/gpl.html</a>
memtest86plus	<a href="http://www.gnu.org/licenses/gpl.html">http://www.gnu.org/licenses/gpl.html</a>
mesa	<a href="http://opensource.org/licenses/MIT">http://opensource.org/licenses/MIT</a>
module-init-tools	<a href="http://www.gnu.org/licenses/old-licenses/gpl-2.0.html">http://www.gnu.org/licenses/old-licenses/gpl-2.0.html</a>
modutils	<a href="http://www.gnu.org/licenses/old-licenses/gpl-2.0.html">http://www.gnu.org/licenses/old-licenses/gpl-2.0.html</a>
monit	<a href="http://www.gnu.org/licenses/gpl.html">http://www.gnu.org/licenses/gpl.html</a>
ncurses	<a href="http://opensource.org/licenses/MIT">http://opensource.org/licenses/MIT</a>
netbase	<a href="http://www.gnu.org/licenses/old-licenses/gpl-2.0.html">http://www.gnu.org/licenses/old-licenses/gpl-2.0.html</a>
openssh-sftp-server	<a href="http://opensource.org/licenses/BSD-3-Clause">http://opensource.org/licenses/BSD-3-Clause</a>
openssl	<a href="http://www.openssl.org/source/license.html">http://www.openssl.org/source/license.html</a>
opkg	<a href="http://www.gnu.org/licenses/old-licenses/gpl-2.0.html">http://www.gnu.org/licenses/old-licenses/gpl-2.0.html</a>
pciutils	<a href="http://www.gnu.org/licenses/old-licenses/gpl-2.0.html">http://www.gnu.org/licenses/old-licenses/gpl-2.0.html</a>
perl	<a href="http://perldoc.perl.org/perlartistic.html">http://perldoc.perl.org/perlartistic.html</a> <a href="http://www.gnu.org/licenses/old-licenses/gpl-1.0.html">http://www.gnu.org/licenses/old-licenses/gpl-1.0.html</a>
php	<a href="http://www.php.net/license/3_01.txt">http://www.php.net/license/3_01.txt</a>
procps	<a href="http://www.gnu.org/licenses/gpl.html">http://www.gnu.org/licenses/gpl.html</a>
read-edid	Free license

Open Source component	Open Source License
rgb	
rockbox-imxtools	<a href="http://www.gnu.org/licenses/old-licenses/gpl-2.0.html">http://www.gnu.org/licenses/old-licenses/gpl-2.0.html</a>
rsyslog	<a href="http://www.gnu.org/licenses/gpl.html">http://www.gnu.org/licenses/gpl.html</a>
splashutils	<a href="http://www.gnu.org/licenses/gpl.html">http://www.gnu.org/licenses/gpl.html</a>
strace	<a href="http://opensource.org/licenses/BSD-3-Clause">http://opensource.org/licenses/BSD-3-Clause</a>
sysfsutils	<a href="http://www.gnu.org/licenses/old-licenses/gpl-2.0.html">http://www.gnu.org/licenses/old-licenses/gpl-2.0.html</a>
sysvinit	<a href="http://www.gnu.org/licenses/old-licenses/gpl-2.0.html">http://www.gnu.org/licenses/old-licenses/gpl-2.0.html</a>
tcpdump	<a href="http://opensource.org/licenses/BSD-3-Clause">http://opensource.org/licenses/BSD-3-Clause</a>
ttf-arphic-uming	
ttf-dejavu-common	
ttf-dejavu-sans-mono	
ttf-dejavu-sans	
ttf-sazanami-gothic	
ttf-sazanami-mincho	
ttf-un-fonts	
udev	<a href="http://www.gnu.org/licenses/old-licenses/gpl-2.0.html">http://www.gnu.org/licenses/old-licenses/gpl-2.0.html</a>
update-modules	<a href="http://www.gnu.org/licenses/old-licenses/gpl-2.0.html">http://www.gnu.org/licenses/old-licenses/gpl-2.0.html</a>
update-rc	<a href="http://www.gnu.org/licenses/old-licenses/gpl-2.0.html">http://www.gnu.org/licenses/old-licenses/gpl-2.0.html</a>
usbutils	<a href="http://www.gnu.org/licenses/old-licenses/gpl-2.0.html">http://www.gnu.org/licenses/old-licenses/gpl-2.0.html</a>
util-linux-ng	<a href="http://www.gnu.org/licenses/gpl.html">http://www.gnu.org/licenses/gpl.html</a> x
server-xorg	<a href="http://opensource.org/licenses/MIT">http://opensource.org/licenses/MIT</a>
zeroconf	<a href="http://www.gnu.org/licenses/gpl.html">http://www.gnu.org/licenses/gpl.html</a>

## Trademarks

Brand and product names mentioned in this manual may be trademarks, registered trademarks or copyrights of their respective holders. All brand and product names mentioned in this manual serve as comments or examples and are not to be understood as advertising for the products or their manufacturers.

## Guarantee and Compensation

Barco provides a guarantee relating to perfect manufacturing as part of the legally stipulated terms of guarantee. On receipt, the purchaser must immediately inspect all delivered goods for damage incurred during transport, as well as for material and manufacturing faults Barco must be informed immediately in writing of any complaints.

The period of guarantee begins on the date of transfer of risks, in the case of special systems and software on the date of commissioning, at latest 30 days after the transfer of risks. In the event of justified notice of complaint, Barco can repair the fault or provide a replacement at its own discretion within an appropriate period. If this measure proves to be impossible or unsuccessful, the purchaser can demand a reduction in the purchase price or cancellation of the contract. All other claims, in particular those relating to compensation for direct or indirect damage, and also damage attributed to the operation of software as well as to other services provided by Barco, being a component of the system or independent service, will be deemed invalid provided the damage is not proven to be attributed to the absence of properties guaranteed in writing or due to the intent or gross negligence or part of Barco.

If the purchaser or a third party carries out modifications or repairs on goods delivered by Barco, or if the goods are handled incorrectly, in particular if the systems are commissioned operated incorrectly or if, after the transfer of risks, the goods are subject to influences not agreed upon in the contract, all guarantee claims of the purchaser will be rendered invalid. Not included in the guarantee coverage are system failures which are attributed to programs or special electronic circuitry provided by the purchaser, e.g. interfaces. Normal wear as well as normal maintenance are not subject to the guarantee provided by Barco either.

The environmental conditions as well as the servicing and maintenance regulations specified in the this manual must be complied with by the customer.



## **EN55022/CISPR22 Class A ITE (Information Technology Equipment)**

Class A ITE is a category of all other ITE which satisfies the class A ITE limits but not the class B ITE limits. Such equipment should not be restricted in its sale but the following warning shall be included in the instructions for use:

**Warning :** This is a class A product. In a domestic environment this product may cause radio interference in which case the user may be required to take adequate measures.

### **Federal Communication Commission Interference Statement**

You are cautioned that changes or modifications not expressly approved by the part responsible for compliance could void the user's authority to operate the equipment.

This equipment has been tested and found to comply with the limits for a Class A digital device, pursuant to Part 15 of the FCC Rules. These limits are designed to provide reasonable protection against harmful interference when the equipment is operated in a commercial environment. This equipment generates, uses, and can radiate radio frequency energy and, if not installed and used in accordance with the instruction manual, may cause harmful interference to radio communications. Operation of this equipment in a residential area is likely to cause harmful interference in which case the user will be required to correct the interference at his own expense.

If this equipment does cause interference with radio communications services, which can be determined by turning the equipment off and on, you are encouraged to try to correct the interference by one or more of the following measures:

- Reorient or relocate the receiving antenna.
- Increase the separation between the equipment and receiver.
- Connect the equipment into an outlet on a circuit different from that to which the receiver is connected.
- Consult the dealer or an experienced radio/TV technician for help.

This device complies with Part 15 of the FCC Rules. Operation is subject to the following two conditions:

1. this device may not cause harmful interference, and
2. this device must accept any interference received, including interference that may cause undesired operation of the device.

FCC RF Radiation Exposure Statement: This device is capable of operating in 802.11a mode. For 802.11a devices operating in the frequency range of 5.15 - 5.25 GHz, they are restricted for indoor operations to reduce any potential harmful interference for Mobile Satellite Services (MSS) in the US. WIFI Access Points that are capable of allowing your device to operate in 802.11a mode (5.15 - 5.25 GHz band) are optimized for indoor use only. If your WIFI network is capable of operating in this mode, please restrict your WIFI use indoors to not violate federal regulations to protect Mobile Satellite Services.

Base Unit FCC ID: RYK-WPEA-121N

Button FCC ID: 2AAED-CLSBTN

### **Compliance Anatel (Brasil)**

1. Este produto está homologado pela Anatel, de acordo com os procedimentos regulamentados pela Resolução nº 242/2000, e atende aos requisitos técnicos aplicados, incluindo os limites de exposição da taxa de absorção específica referente a campos elétricos, magnéticos e eletromagnéticos de radiofrequência de acordo com as resoluções nº 303/2002 e 533/2009. Para maiores informações, consulte o site da Anatel - [www.anatel.gov.br](http://www.anatel.gov.br)
2. Este equipamento opera em caráter secundário, isto é, não tem direito a proteção contra interferência prejudicial, mesmo de estações do mesmo tipo, e não pode causar interferência a sistemas operando em caráter primário.

### **Canada, Industry Canada (IC) Notices**

This device complies with Industry Canada licence-exempt RSS standard(s). Operation is subject to the following two conditions: (1) this device may not cause interference, and (2) this device must accept any interference, including interference that may cause undesired operation of the device.

### **Radio Frequency (RF) Exposure Information**

The radiated output power of the Barco Wireless Device is below the Industry Canada (IC) radio frequency exposure limits. The Barco Wireless Device should be used in such a manner such that the potential for human contact during normal operation is minimized.

Base Unit IC ID: IC: 4104 A-AR5BHB116

Button IC ID: 9393B-CLSBTN

### **IC Antenna statement**

Under Industry Canada regulations, this radio transmitter may only operate using an antenna of a type and maximum (or lesser) gain approved for the transmitter by Industry Canada. To reduce potential radio interference to other users, the antenna type and its gain should be so chosen that the equivalent isotropically radiated power (e.i.r.p.) is not more than that necessary for successful communication.

This radio transmitter 4104 A-AR5BHB116 has been approved by Industry Canada to operate with the antenna types listed below with the maximum permissible gain and required antenna impedance for each antenna type indicated. Antenna types not included in this list, having a gain greater than the maximum gain indicated for that type, are strictly prohibited for use with this device.

Type: Dipole

Maximum Peak Gain: 2 dBi

Impedance: 50 Ohm

### Canada, avis d'Industry Canada (IC)

Le présent appareil est conforme aux CNR d'Industrie Canada applicables aux appareils radio exempts de licence. L'exploitation est autorisée aux deux conditions suivantes : (1) l'appareil ne doit pas produire de brouillage, et (2) l'utilisateur de l'appareil doit accepter tout brouillage radioélectrique subi, même si le brouillage est susceptible d'en compromettre le fonctionnement.

### Informations concernant l'exposition aux fréquences radio (RF)

La puissance de sortie émise par l'appareil de sans fil Barco est inférieure à la limite d'exposition aux fréquences radio d'Industry Canada (IC). Utilisez l'appareil de sans fil Barco de façon à minimiser les contacts humains lors du fonctionnement normal.

IC ID Unité de Base: 4104 A-AR5BHB116

IC ID Button : 9393B-CLSBTN

### Déclaration d'antenne d'Industry Canada (IC)

Conformément à la réglementation d'Industry Canada, le présent émetteur radio peut fonctionner avec une antenne d'un type et d'un gain maximal (ou inférieur) approuvé pour l'émetteur par Industry Canada. Dans le but de réduire les risques de brouillage radioélectrique à l'intention des autres utilisateurs, il faut choisir le type d'antenne et son gain de sorte que la puissance isotrope rayonnée équivalente (p.i.r.e.) ne dépasse pas l'intensité nécessaire à l'établissement d'une communication satisfaisante.

Le présent émetteur radio 4104 A-AR5BHB116 a été approuvé par Industry Canada pour fonctionner avec les types d'antenne énumérés ci-dessous et ayant un gain admissible maximal et l'impédance requise pour chaque type d'antenne. Les types d'antenne non inclus dans cette liste, ou dont le gain est supérieur au gain maximal indiqué, sont strictement interdits pour l'exploitation de l'émetteur.

Type: Dipole

Gain maximum: 2 dBi

Impédance: 50 Ohm

### NCC Statement

第十二條	經型式認證合格之低功率射頻電機，非經許可，公司、商號或使用者均不得擅自變更頻率、加大功率或變更原設計之特性及功能。
第十四條	低功率射頻電機之使用不得影響飛航安全及干擾合法通信；經發現有干擾現象時，應立即停用，並改善至無干擾時方得繼續使用。前項合法通信，指依電信法規定作業之無線電通信。低功率射頻電機須忍受合法通信或工業、科學及醫療用電波輻射性電機設備之干擾。

底座 CCAF11LP0930T5

按鈕 CCAJ13LP1890T2

### KCC Statement

기본 장치	등록번호 KCC-RMM-BVY-CLICKBASE 기자재의 명칭 : 무선데이터통신시스템용 무선기기 모델명 : CLICKSHARE-BASE 본 기기는 내부에 인증 받은 무선모듈(인증번호 : ATH-AR5BHB116)을 내장하고 있음 본 기기와 20 cm 이상 떨어져서 사용하시기 바랍니다
버튼	등록번호 KCC-CRM-BVY-CLICKBUTTON 기자재의 명칭 : 특정소출력 무선기기(무선데이터통신시스템용 무선기기) 모델명 : CLICKSHARE-BUTTON

---

# TABLE OF CONTENTS

<b>1. Introduction</b> .....	<b>3</b>
1.1 Versions .....	3
1.2 About this guide .....	3
1.3 Symbols and fonts .....	4
<b>2. Introduction to ClickShare</b> .....	<b>5</b>
2.1 About the ClickShare product .....	5
2.2 About the Base Unit .....	6
2.3 About the Button .....	8
2.4 About the Tray .....	9
2.5 ClickShare App .....	9
<b>3. Getting Started</b> .....	<b>13</b>
3.1 Powering the Base Unit on and off .....	13
3.2 Basic Use .....	14
3.3 Advanced Use .....	17
3.4 Use of an iOS device with ClickShare Link .....	19
3.5 User Interface .....	20
3.6 Capture mode: detailed - fast .....	20
3.7 Shared desktop: primary - extended .....	21
3.8 Audio configuration .....	23
3.9 Pairing .....	25
<b>4. Troubleshooting</b> .....	<b>29</b>
4.1 Basic Troubleshooting .....	29
<b>5. Environmental information</b> .....	<b>31</b>
5.1 Disposal information .....	31
5.2 Rohs compliance .....	31
5.3 Production address .....	32
<b>Index</b> .....	<b>33</b>



# 1. INTRODUCTION

## Overview

- Versions
- About this guide
- Symbols and fonts

## 1.1 Versions

### Regional versions

Depending on the location where you buy the ClickShare product, the Base Unit and accessories are regionalized. By the time of release of this manual, 4 regional versions of ClickShare are available:

- Europe
- North America
- China
- Japan



**The regional version of your ClickShare cannot be changed. That means that you cannot use it in another region.**

For more information on the regional variants, refer to the ClickShare Installation Guide (R5900004).

## 1.2 About this guide

### This manual

Partnumber	Description	Level
R5900001	User Guide	User

### Available System documentation

This guide is part of the documentation set describing the ClickShare product.

Guide	Article number
User Guide	R5900001
Quick Start Guide	R5900002
Installation Guide	R5900004
Safety Guide	R5900005
Service Guide	R5900006
Button Guide	R5900007
Rack Mount Guide	R5900008
Recycling Manual	R5900009

A printed copy of the Safety Guide and Quick Start Guide is included in the ClickShare box at purchase. Please check online for the other documents.



**Always check for the latest version of the manual on [www.barco.com/clickshare](http://www.barco.com/clickshare) Click on Visit the ClickShare product page and go to tab Downloads..**



Depending on the ClickShare version, some graphics might be different to the ones used in this manual. This however does not have any effect to the functionality.

---





The User Guide describes how to use ClickShare. It also contains a basic troubleshooting part where you can search for a solution when a problem occurs.

## 1.3 Symbols and fonts

---

### Symbol overview

The following icons are used in the manual :

	Caution
	Warning
	Info, term definition. General info about the term
	Note: gives extra information about the described subject
	Tip: gives extra advice about the described subject

### Font overview

- Buttons are indicated in bold, e.g. **OK**.
- Menu items are indicated in *italic*.
- Step related notes, tips, warnings or cautions are printed in *italic*.
- Procedure related notes, tips, warnings or cautions are printed in **bold** between 2 lines preceded by the corresponding icon.

## 2. INTRODUCTION TO CLICKSHARE

### Overview

- About the ClickShare product
- About the Base Unit
- About the Button
- About the Tray
- ClickShare App

### 2.1 About the ClickShare product

#### ClickShare sets

ClickShare makes connecting to the meeting room's video system a matter of clicking a Button. This one click wonder not only helps the presenter get the presentation on-screen in a second, but it also allows the other people in the meeting to participate more actively. The result is enhanced meeting efficiency and better decision-making.

At the moment 4 different sets are available on the market. Each set is sold in its specific region and it can only be used in that specific region.

#### Components ClickShare set

A standard ClickShare set consists of a Base Unit, a Tray and 4 Buttons. Depending on the location where you buy the product, the software of the Base Unit is different. If needed, you can buy additional Buttons and Trays.

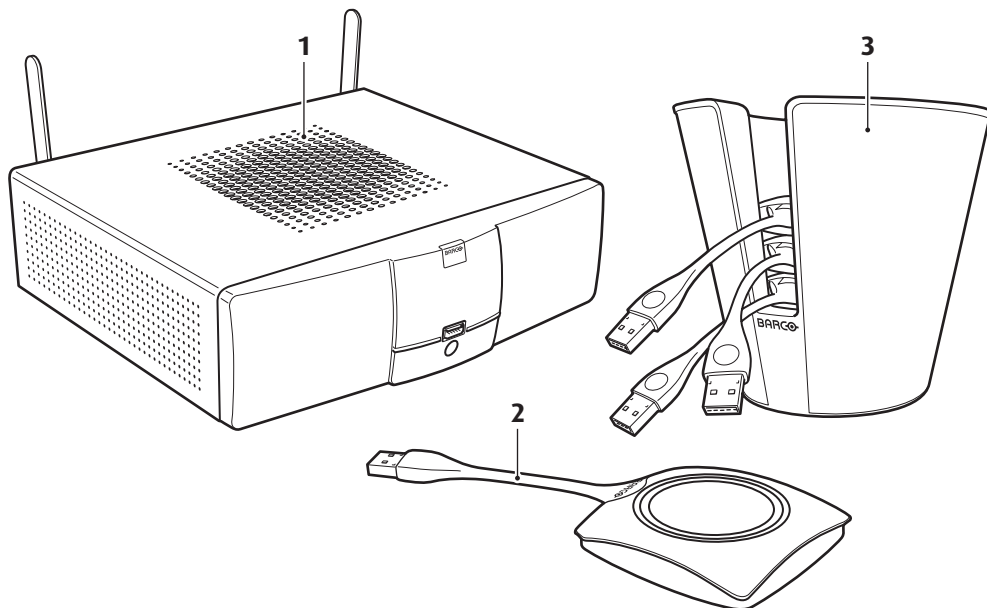

Image 2-1  
ClickShare main components

1	Base unit
2	Button
3	Tray

#### Accessories included

Depending on the country where you buy the product, the following regionalized accessories are also included in the ClickShare box.

Regional version	Contains	Accessories included
R9861005EU	<ul style="list-style-type: none"> <li>• R9861006BEU</li> <li>• 4x R9861006D01</li> <li>• R9861006T01</li> </ul>	<ul style="list-style-type: none"> <li>• power cables CEE7 and BS 1363</li> <li>• wall/ceiling mounting brackets</li> <li>• a DVI to VGA converter</li> </ul>

## 2. Introduction to ClickShare

Regional version	Contains	Accessories included
R9861005JP	<ul style="list-style-type: none"><li>• R9861006BJP</li><li>• 4x R9861006D01</li><li>• R9861006T01</li></ul>	<ul style="list-style-type: none"><li>• power cable JIS C8303</li><li>• wall/ceiling mounting brackets</li><li>• a DVI to VGA converter</li></ul>
R9861005CN	<ul style="list-style-type: none"><li>• R9861006BCN</li><li>• 4x R9861006D01</li><li>• R9861006T01</li></ul>	<ul style="list-style-type: none"><li>• power cable GB 2099</li><li>• wall/ceiling mounting brackets</li><li>• a DVI to VGA converter</li></ul>
R9861005NA	<ul style="list-style-type: none"><li>• R9861006BNA</li><li>• 4x R9861006D01</li><li>• R9861006T01</li></ul>	<ul style="list-style-type: none"><li>• power cable NEMA 5/15</li><li>• wall/ceiling mounting brackets</li><li>• a DVI to VGA converter</li></ul>
R9861005WW	<ul style="list-style-type: none"><li>• R9861006BEU</li><li>• 4x R9861006D01</li><li>• R9861006T01</li></ul>	<ul style="list-style-type: none"><li>• power cables CEE7 and BS 1363</li><li>• wall/ceiling mounting brackets</li><li>• a DVI to VGA converter</li></ul>

Contact your local sales representative for the correct regional variant to be used in your country.

### Optional accessory: ClickShare Link

Order number: R9861001



Image 2-2  
ClickShare Link

Using the optional ClickShare Link allows you to use your iPad with ClickShare.

Via a cable or wireless via Apple TV, the complete content of your iPad touchscreen is transferred to the meeting room screen

A ClickShare Link kit contains:

- 1 ClickShare Link unit
- 1 DVI to HDMI convertor
- 1 power adapter
- 4 power clips
- 1 USB cable

## 2.2 About the Base Unit

### Base Unit functionality

The Base Unit receives the wireless input from the Buttons and controls the content of the meeting room display and the sound of the meeting room's audio system.

The Base Unit can be inside a cabinet in the meeting room, or put on the meeting room table or mounted on a wall or ceiling. Check the Installation Guide for instructions on how to install the Base Unit.



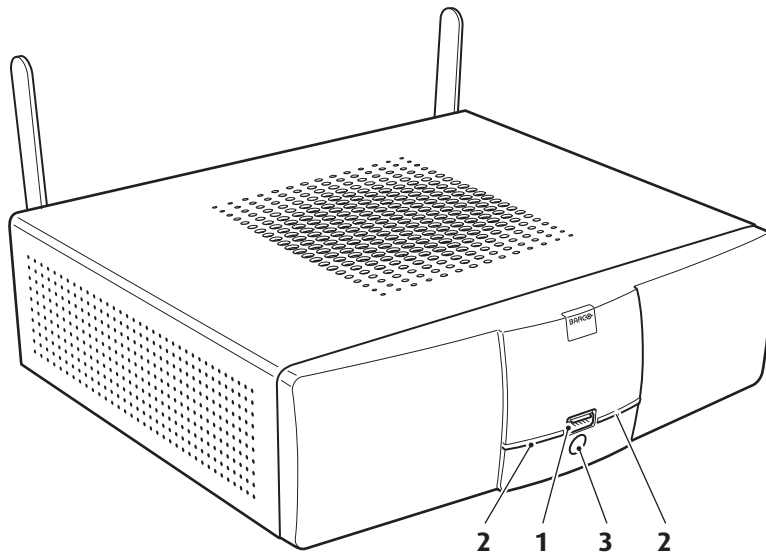

Image 2-3  
The Base Unit

1	USB port
2	Status LED strip
3	Standby Button

Table 2-3

### USB Port

The USB port is used to update the software of both the Base Unit and the Buttons.

When plugging in the Button into the Base Unit, the Button is paired to the Base Unit. The Base Unit checks whether the software and firmware of the Button is up to date. If not, the Base Unit updates the software and/or firmware.

### Status LED strips

The color of the LEDs at the front of the Base Unit give information on the status of the system.

LEDs behavior	Explanation
static red	<ul style="list-style-type: none"> <li>receiving content from the Buttons and streaming towards the display.</li> <li>pairing and software update of the Button is done. You can now unplug the Button from the Base Unit.</li> <li>during the first phase of the Base Unit boot process.</li> </ul>
blinking white	<ul style="list-style-type: none"> <li>system is starting up (during the second phase)</li> <li>Button pairing is in progress</li> <li>software update of the Base Unit</li> </ul>
slow blinking white	<ul style="list-style-type: none"> <li>standby mode (i.e. muting the display output)</li> </ul>
static white	<ul style="list-style-type: none"> <li>awake and ready (i.e. showing the welcome message on the display)</li> <li>pairing is done</li> </ul>
red blinking	<ul style="list-style-type: none"> <li>an error occurred</li> </ul>

### Standby button

The button at the front of the Base Unit has a power on/off function and a standby function.

- When the system is awake, a short push triggers the system to go into standby mode.
- When the system is in standby mode, a short push triggers the system to wake up.
- When the system is powered on, a long push makes the system to shut down and power off.
- When the system is shut down, a long push or short push triggers the system to start up.

## 2.3 About the Button

### Button functionality

By default, the ClickShare Set comes with four Buttons. A Button contains three main functional components.

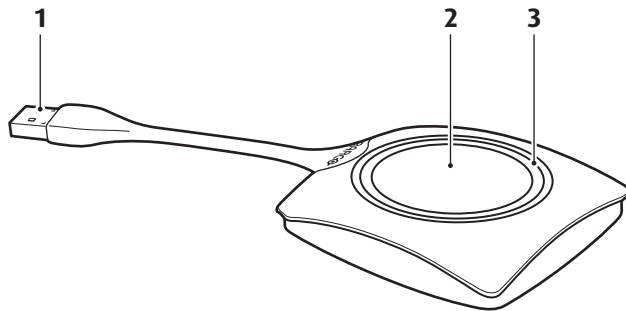

Image 2-4  
The Button

1	USB connector
2	Button
3	LED ring

Table 2-5



**Handle the Button cable with care. Rough handling might cause defects.**

### USB connector

Using the USB connector the Button can be plugged into a laptop (for sharing your screen) or in the Base Unit (for pairing the Button to the Unit or updating its software).

### Button

Click the Button to display the content of the laptop's screen on the meeting room display. Clicking the Button during the meeting will toggle the sharing of the screen.

Holding the Button for 2 seconds brings the content of the laptop's screen as full screen on the meeting screen, removing other sources currently displayed.

### LED ring

The LED ring indicates the current status of your ClickShare.

LEDs behavior	Explanation
white blinking	<ul style="list-style-type: none"> <li>the Button is plugged in the laptop and initializing or waiting for the user to start the ClickShare application.</li> <li>pairing/software update of the Button in the Base Unit is in progress.</li> </ul>
static white	<ul style="list-style-type: none"> <li>ClickShare is ready to start sharing your screen.</li> <li>pairing is done. You can now unplug the Button from the Base Unit.</li> </ul>
static red	<ul style="list-style-type: none"> <li>sharing your screen with the display.</li> <li>pairing and software update is done. You can now unplug the Button from the Base Unit.</li> </ul>
red blinking	<ul style="list-style-type: none"> <li>an error occurred.</li> </ul>
off (no light)	<ul style="list-style-type: none"> <li>the Button is not or not properly inserted into the USB port.</li> <li>the Button might be defective.</li> <li>the USB port or computer might be defective.</li> </ul>

---

## 2.4 About the Tray

---

### Tray functionality

The function of the Tray is to hold the Buttons on the table when the meeting has finished. The Tray can hold up to 4 Buttons.

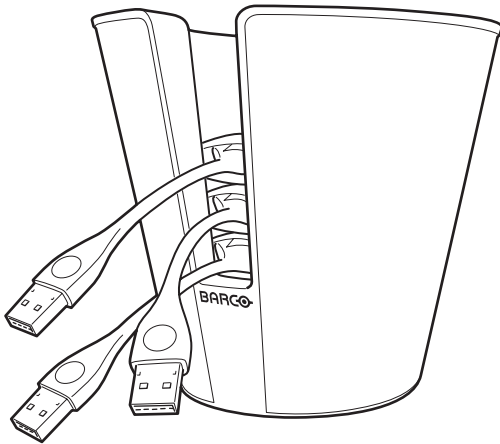

Image 2-5  
Tray

---

## 2.5 ClickShare App

---

### Introduction



The ClickShare App is freely available from the Apple store. It allows one to display static content such as PDF and JPG documents on iPads and iPhones.

The App is like a virtual Button, including the multiple on screen composition and the show-me-only capability. Content from tablet devices running the App is treated by the Base Unit just like content coming from a physical Button. Although the App does not provide an exact real-time mirroring of the client device's screen like the Button (which is not possible for technical and legal reasons), it is a bit better than pure static content in the sense that also zooming in and out using the pinch gesture and annotating using a virtual pen are possible. The App also has a shot-and-show capability. This means that while the App is running in the background, a picture taken with the built-in camera or a snapshot taken using the two button gesture will automatically be sent to the Base Unit.

Before you can use your iOS device with the ClickShare App, you have to connect the wifi with the ClickShare SSID. Follow the instructions as given in your iOS device user guide.

## 2. Introduction to ClickShare

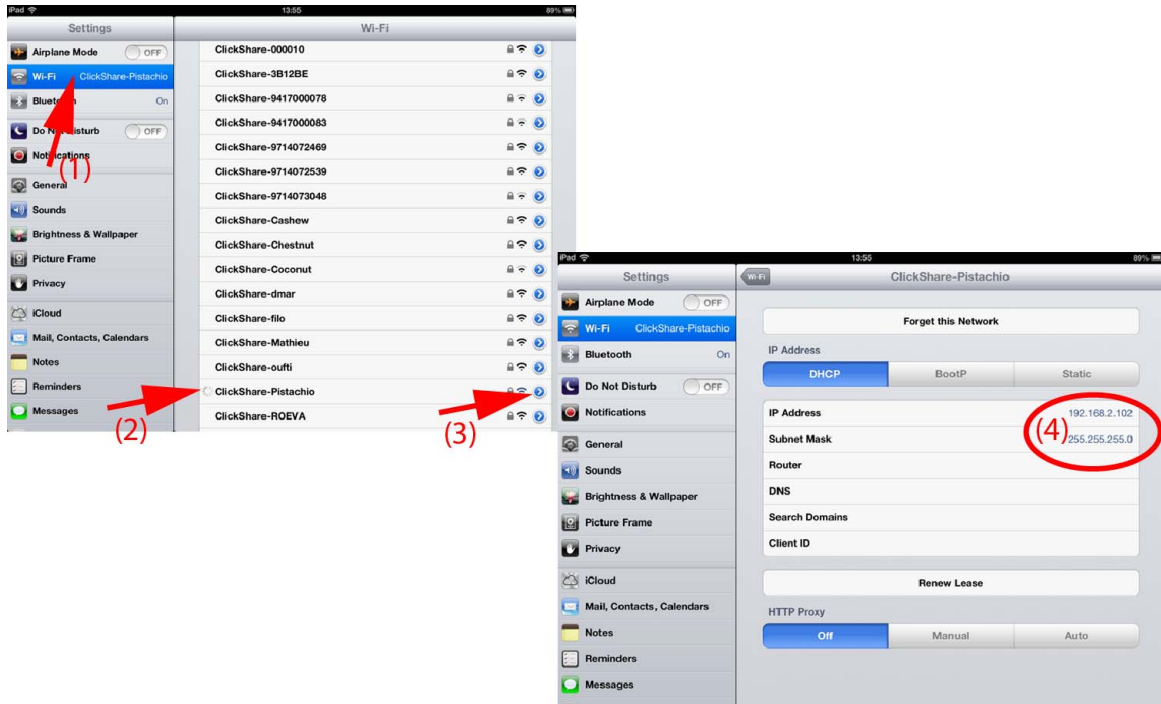

Image 2-6

- 1 WiFi connection
- 2 Spinning circle, means connected but no internet connection
- 3 Click on arrow to open the IP addresses
- 4 Valid IP address from ClickShare



Image 2-7

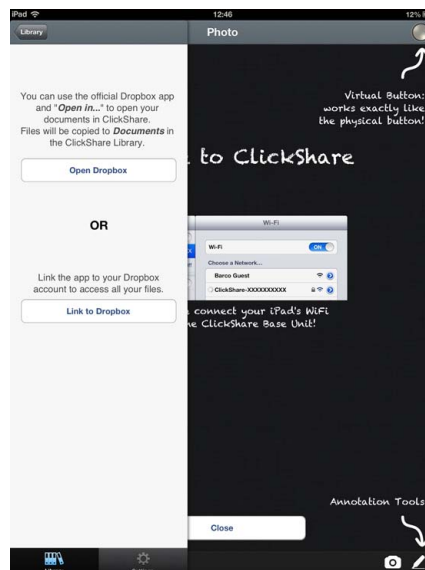

Image 2-8

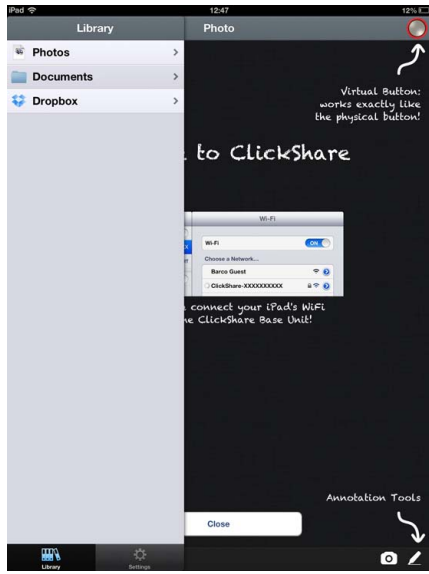

Image 2-9

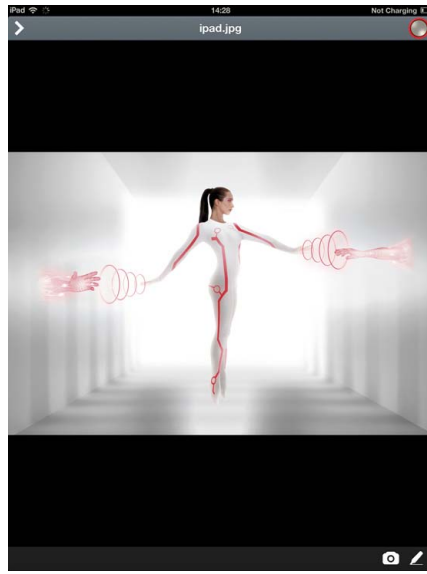

Image 2-10

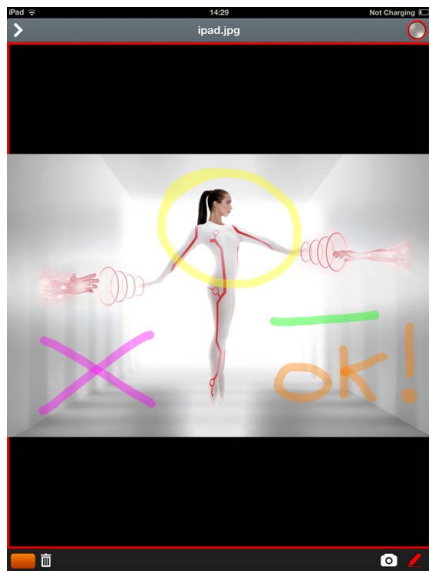

Image 2-11



Image 2-12



Image 2-13

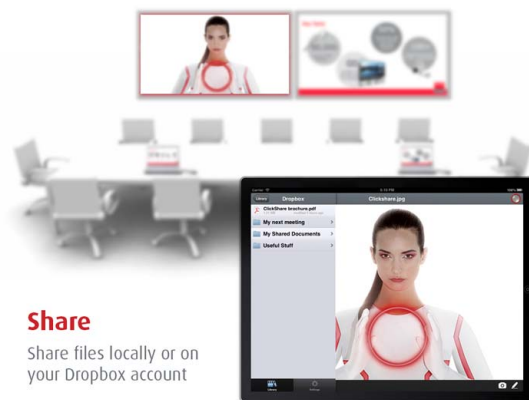

Image 2-14

## 2. Introduction to ClickShare

---

### Clarify

Click the marker, pick your color, and annotate



Image 2-15



### Zoom

Pinch and zoom to show extra detail

Image 2-16

### Shot and show

Make a screenshot to share any content



Image 2-17

## 3. GETTING STARTED

### Overview

- Powering the Base Unit on and off
- Basic Use
- Advanced Use
- Use of an iOS device with ClickShare Link
- User Interface
- Capture mode: detailed - fast
- Shared desktop: primary - extended
- Audio configuration
- Pairing

### 3.1 Powering the Base Unit on and off

#### About power mode

You can power on and off the Base Unit and bring the system in standby mode. In standby mode the system mutes the output signal to the display. If your display supports this, it will automatically enter power saving mode.

#### To power on the Base Unit or awake it from standby

1. When the Base Unit is shut down, set the rocker switch at the back of the Base Unit to "1". Refer to image 3-1.

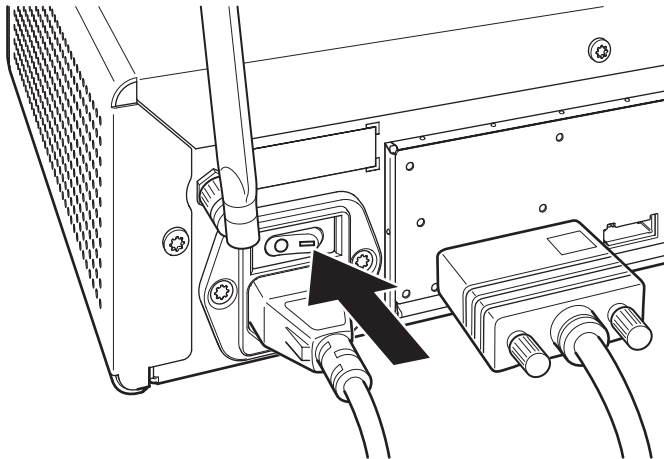

Image 3-1  
Rocker switch

2. If the system does not start up automatically, push the standby button shortly. Refer to image 3-2.

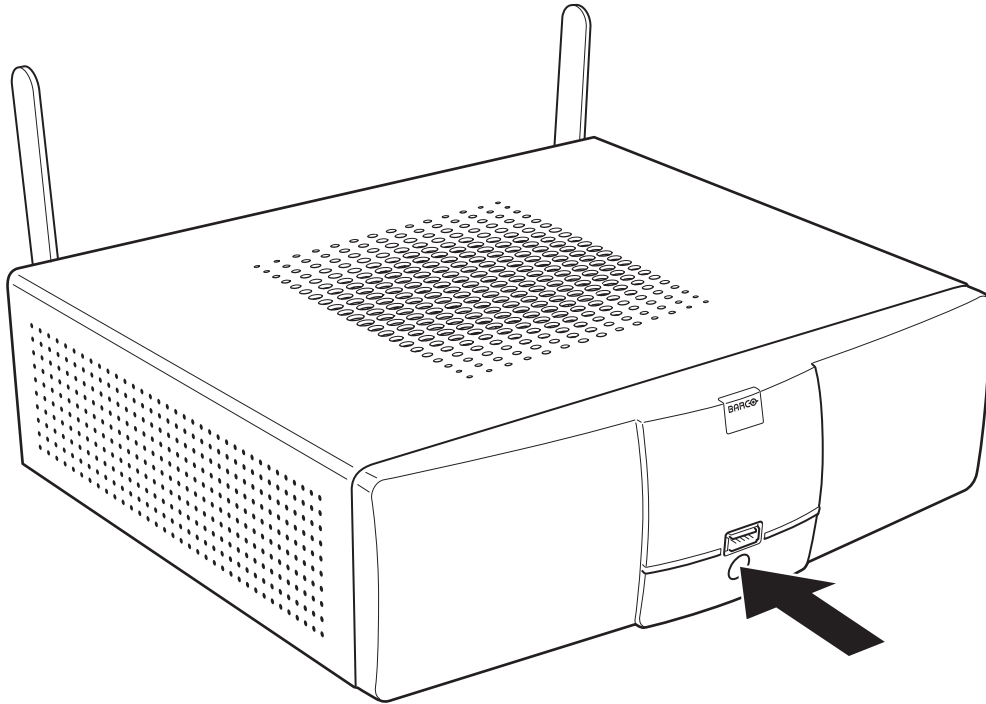

Image 3-2  
Standby button

The system is now powered on.

#### To put the Base Unit in standby mode or awake it

1. Push the standby button shortly.  
Refer to image 3-2.

**Note:** *If you plug in a Button into your laptop and connect to it, the Base Unit automatically wakes up from standby (enable its display output).*

*If no Buttons have been connected to it for some time, the Base Unit can automatically enter standby mode.*

#### To shut down the Base Unit

The Base Unit can be shut down in two ways :

1. Push the standby button until the Base Unit shuts down.  
Refer to image 3-2.
2. Set the rocker switch at the back of the Base Unit to "0".  
Refer to image 3-1.

## 3.2 Basic Use

---

### Basic functionality

When entering a meeting room equipped with ClickShare and if the display is not in power saving mode, the ClickShare wallpaper is shown on the display. The content of the wallpaper depends on the setup.





Image 3-3

Starting to use ClickShare is now very simple.

**To start using ClickShare**

1. Take a Button out of the Tray.

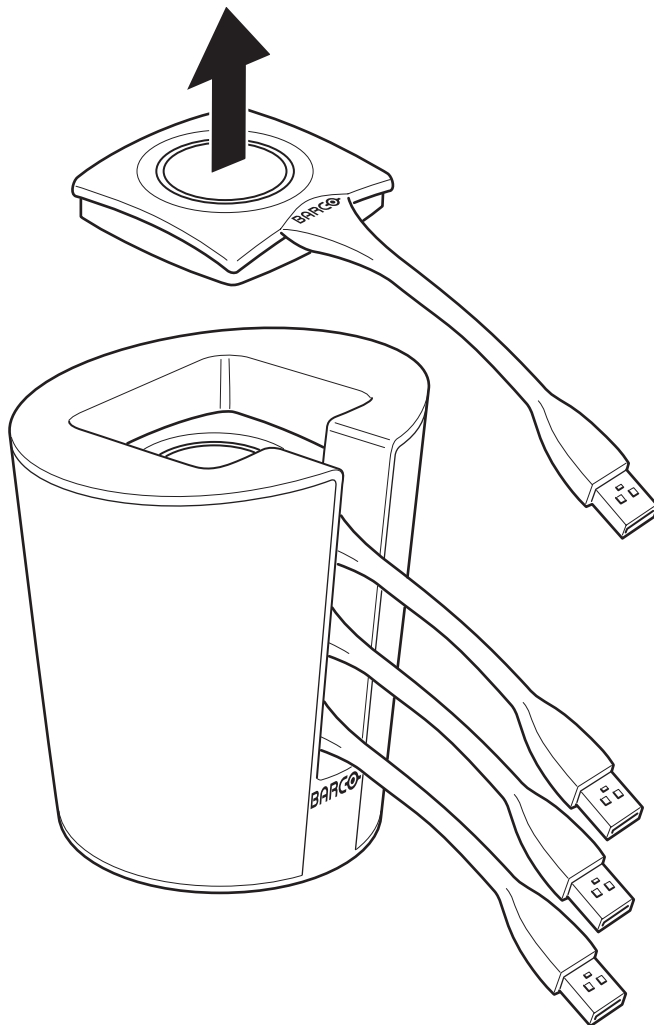

Image 3-4

2. Insert the Button into a USB port of your laptop.

### 3. Getting Started

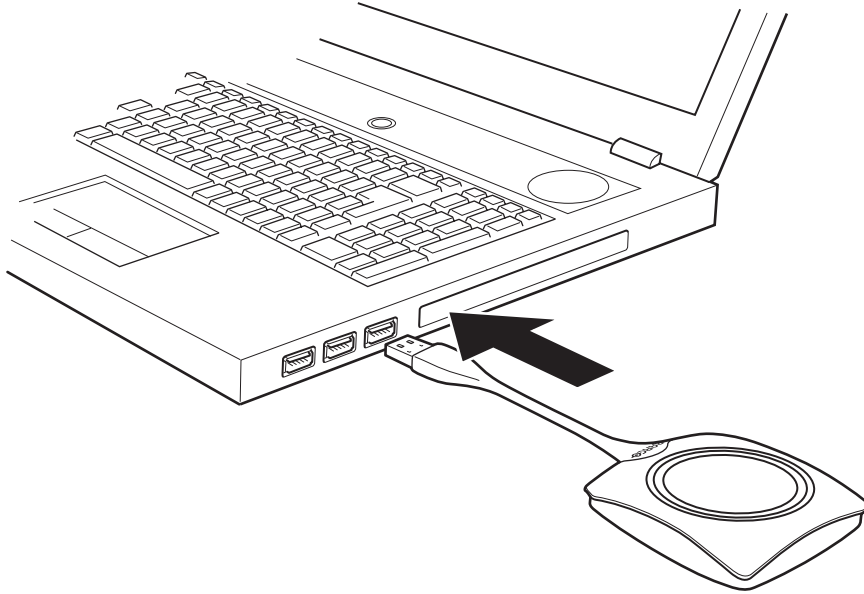

Image 3-5

The LEDs of the Button start flashing white.

On your laptop a new drive appears.

Two situations are possible now:

- A launcher is preinstalled on your laptop (downloaded from the Base Unit or Barco website, or deployed company-wide by your IT department). ClickShare is immediately available. You can continue with step 5.
- nothing is pre-installed. Continue with step 3.

3. Browse to and double-click the ClickShare drive on your laptop.

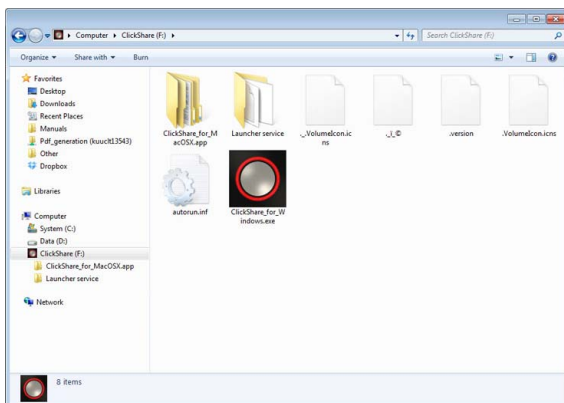

Image 3-6  
Windows environment

4. Double-click the ClickShare application.

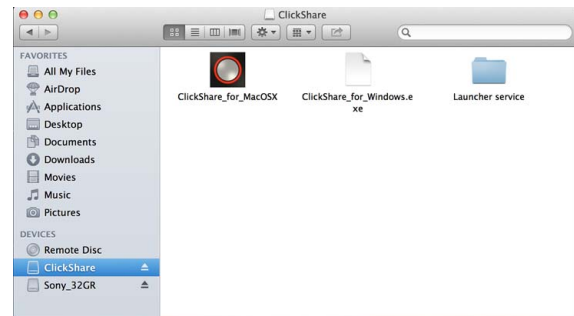



Image 3-7  
MAC environment

The ClickShare client software starts and its icon appears in the system tray.

On a Windows computer: 

On a Macintosh: 

When the system is ready for use, a message appears close to the systray icon.

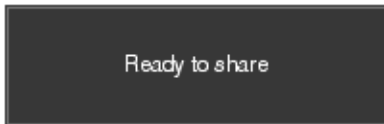



Image 3-8

The LEDs of the Button are static white.

- To share your screen on the display, click the Button.

The LEDs of the Button become static red and your screen appears on the display. When audio is enabled on the ClickShare Base Unit, the audio of your laptop is also available on the audio output of the Base Unit and it will be played via the meeting room audio system. The icon return to the same state as in step 4.

In the system tray, the ClickShare icon starts rotating. On Windows computers the icon changes into .

The name of the user logged on to the laptop which is sharing its content is briefly shown in the bottom left corner of the added content.

ClickShare automatically scales the content of your screen to the resolution of the meeting room display. The aspect ratio of your screen is maintained to make sure the proportions are correct.

- To remove your content from the display, click the Button again.

The LEDs of the Button become static white.

- When leaving the meeting room, unplug the Button from your laptop and put it back in the Tray.

No trace of the ClickShare application is left on your laptop.

### 3.3 Advanced Use

#### Advanced functionality

ClickShare can show the content of up to four wireless sources or three wireless sources and one ClickShare Link (for an iPad) on the meeting room display(s) at the same time. A wireless source is a ClickShare Button, or either an iPad or android device sharing via the ClickShare app. This means by clicking their Button, clicking the virtual button in the ClickShare app or connecting an iOS device through the ClickShare Link, four persons in the meeting room can display their screens simultaneously. They appear as follows:

For a meeting room with a single display:

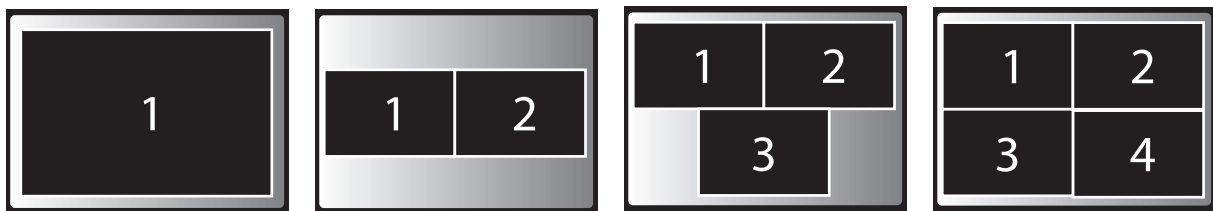

1 user

2 users

3 users

4 users

Image 3-9  
Position on single display

For a meeting room with a dual display:

### 3. Getting Started

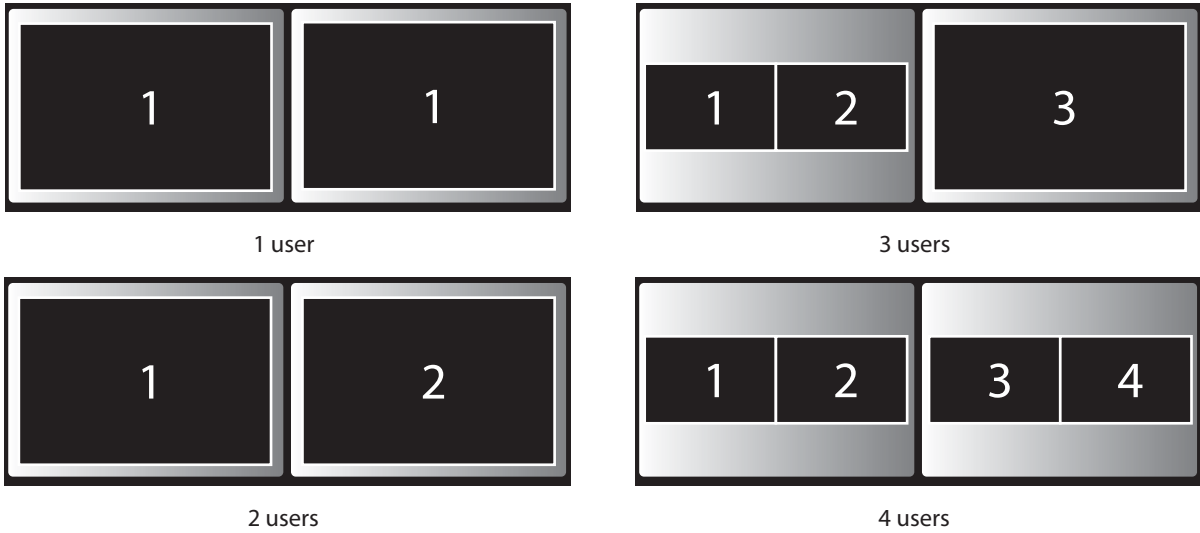

Image 3-10  
Position on Dual screen

One display must support Display Port, otherwise an adapter piece from display port to DVI must be used.

For a single display 2560x1080 Panoramic setup

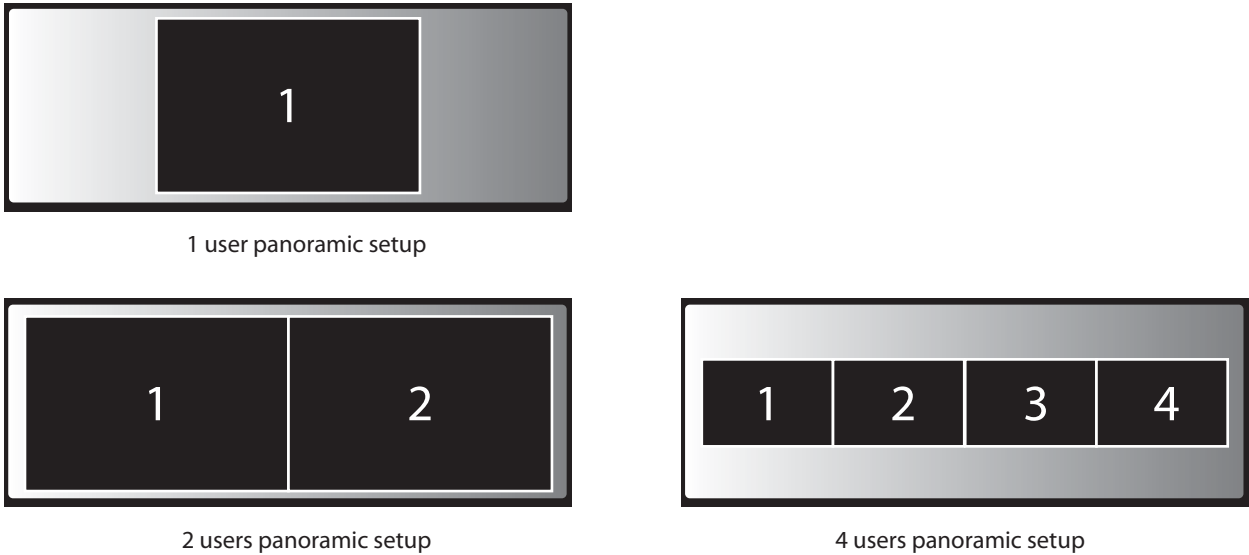

Image 3-11

For Panoramic projectors which require Dual Link DVI in, use the Barco kit B5606021 to convert DisplayPort into Dual Link DVI.



Image 3-12  
DisplayPort convertor

If you are the fifth user who wants to share his screen, you are blocked. A message appears on your screen telling you the maximum number of users being displayed simultaneously has been reached. You can decide to wait until one of the four users removes his content from the display or you can decide to show your content full screen. In that case, the four screens that were being displayed are removed and your screen is displayed full screen.

#### To show your content on the display full screen

1. Click and hold the Button for 2 seconds.

Your content is shown full screen on the display. If other persons were sharing their content on the display, their screens are removed. Their Button's LEDs are now shining white again.

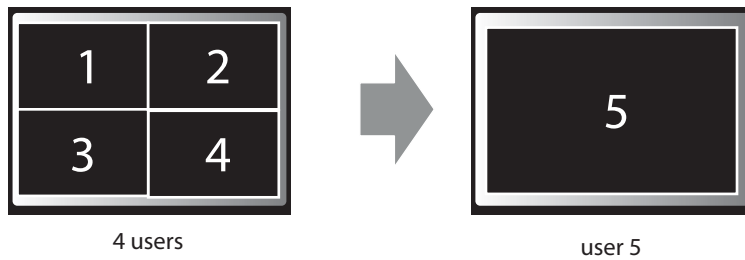

Image 3-13  
Single display

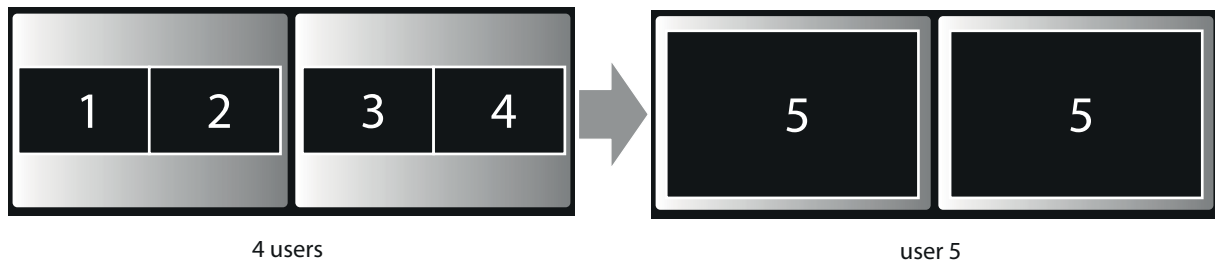

Image 3-14  
Dual display

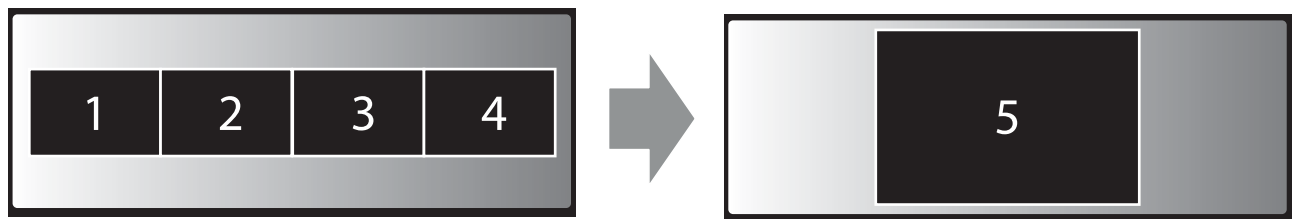

Image 3-15  
Panoramic display



When you click again, your content is removed and the Base Unit shows the welcome screen again. The content of the previous users is not restored on the display.

### 3.4 Use of an iOS device with ClickShare Link

#### About using an iOS device with ClickShare Link

The content of the iOS device touchscreen can be displayed on the large meeting room display(s) as one of the possible sources. The optional ClickShare Link must be installed in the meeting room before an iOS device can participate by sharing its screen content. For more information about the physical installation of ClickShare Link in combination with an iOS device, consult ClickShare's installation guide (R5900004)

#### Necessary parts

- a ClickShare Link
- an HDMI cable
- optional: an iOS device HDMI adapter or an Apple TV

#### Connection with cable

1. Connect the iOS device HDMI convertor to your iOS device.
2. Connect the ClickShare Link to the power and to a rear USB port of the Base Unit.
3. Connect the HDMI port of the iOS device to the input of the ClickShare Link.

The content of the screen will be displayed on the meeting room screen.

### Connection via Apple TV

As per the above but connect the ClickShare Link input to the Apple TV instead of the iOS device.

1. Connect to the appropriate network and start sharing by enabling *AirPlay mirroring*. For more information on how to setup, consult the iOS device's user guide.

**Note:** Always use *AirPlay mirroring*. Streaming is not supported.

## 3.5 User Interface

### User Interface functionality

After launching the client, the ClickShare icon appears in the system tray.

### ClickShare context menu

The content of the context menu is related to the operating system.

1. Right-click the ClickShare icon in the system tray.

The context menu appears.

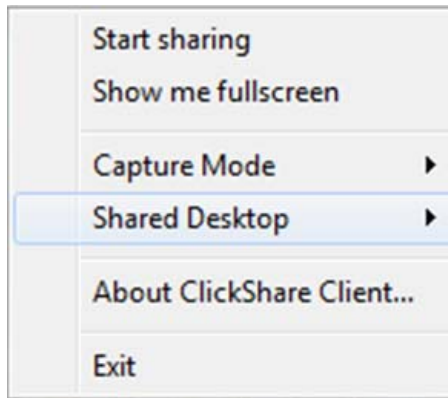

Image 3-16  
Context menu

2. From the list, click the action you want to perform.

Click	To	Result
Start sharing	to show your screen on the display.	The LEDs of your Button become red.
Show me fullscreen	to bring the content of your screen on the display full screen.	The screens of other users that were shown on the display disappear.
Capture mode (only for Windows XP, Windows7 and Windows8)	to choose between detailed and fast	Tune video performance and quality
Shared desktop (only for Windows7 and Windows8)	to select primary or extended desktop	Depending on the selection the primary or the extended display is displayed.
About ClickShare Client	to find out the ClickShare software version.	Here you can find more information on the ClickShare software version.
Exit	to close ClickShare.	The ClickShare icon disappears from the system tray and the LEDs of the Button start blinking white.

## 3.6 Capture mode: detailed - fast



Only for Windows XP, Windows7 and Windows8

### About capture mode

Detailed capture mode may capture more details and overlays but video throughput may decrease a bit. Selecting this mode will change the window settings and switch off the GPU accelerator of the video card.

Fast capture mode may capture faster but it may lose some information.

Default setting: Detailed

### How to change

1. Right click on the ClickShare icon in the system tray (1).

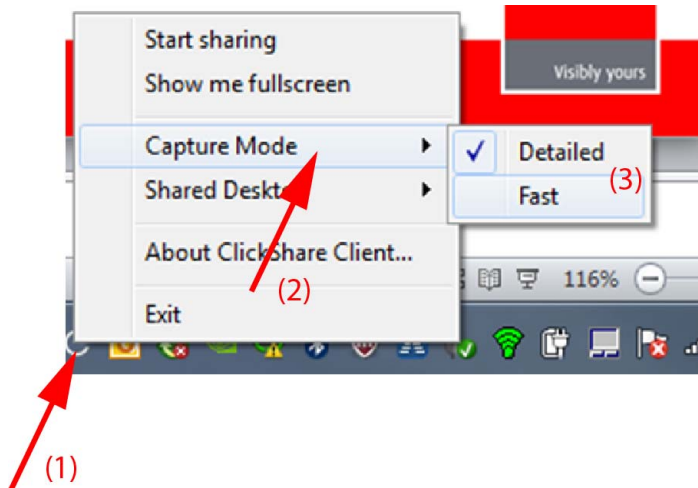

Image 3-17  
Capture mode selection

A context menu opens.

2. Select *Capture mode* (2).

3. Select the desired setting (3).

Detailed : more information but slower

Fast: fast capturing for higher video throughput.

## 3.7 Shared desktop: primary - extended



Only for Window7 and Windows8

### About shared desktop

Depending on your selection, your primary screen or your extended screen will be captured and displayed via ClickShare. That extended screen can be a physical screen or a virtual screen.

With extended desktop you can take advantage of both your laptop screen and the central meeting room display. Presentation notes or other material on primary screen will not be displayed to everyone.

PC with virtual extended screen:



Image 3-18

Primary screen displayed on the PC, extended screen displayed on the meeting room display.

### 3. Getting Started

---



Image 3-19

PC with one extended screen connected. That extended screen will be captured and displayed on the meeting room display.



Image 3-20

PC with two extended screens connected. The first extended screen, screen 2 will always be captured and displayed on the meeting room display.



To know if your system supports the extended desk top feature, press **Window key + P**. It should bring up the following pop-up on screen:



Image 3-21

#### How to select

1. Right click on the ClickShare icon in the system tray (1).



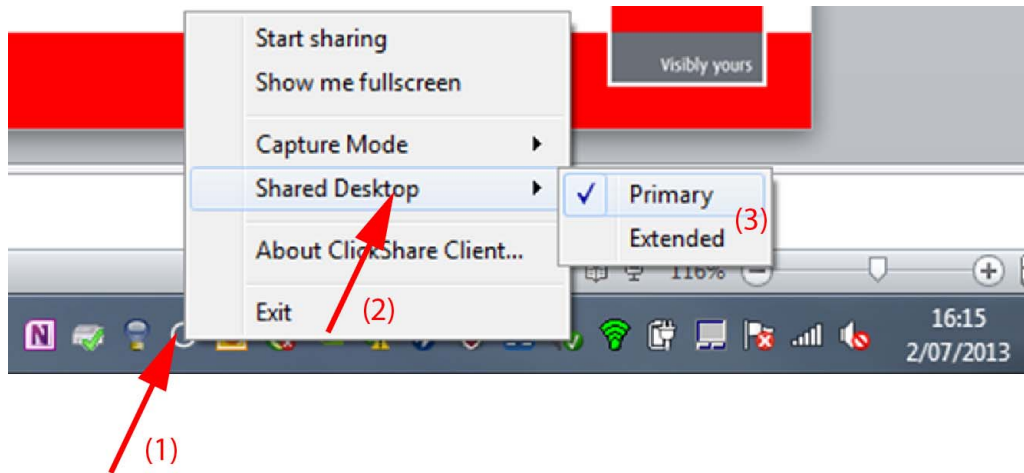

Image 3-22  
Shared desktop selection

A context menu opens.

2. Select *Shared Desktop* (2).
3. Select the desired setting (3).

Primary : the primary PC screen is displayed on the meeting room display.

Extended always the secondary screen is displayed on the meeting room display.

#### Known issue

- Virtual Extended Desktop not supported on some Windows7 and Windows8 systems due to a problem in recent versions of the AMD graphical driver. Downgrade to an older version of the driver might resolve the issue.

## 3.8 Audio configuration

### Audio configuration

The audio signals from the different users are mixed in the Base Unit to one output signal. Each connected user must control his own audio signal using the audio configuration of his computer. If he does not want to broadcast his audio signal, he has to mute audio on his computer.

For some operating system, it is necessary to set ClickShare as your default output device. Once you unplug the Button, the default setting is switched back to the previous setting.

#### Set ClickShare as default in Windows 7

1. Right click on the speaker icon in the system tray (1).

### 3. Getting Started

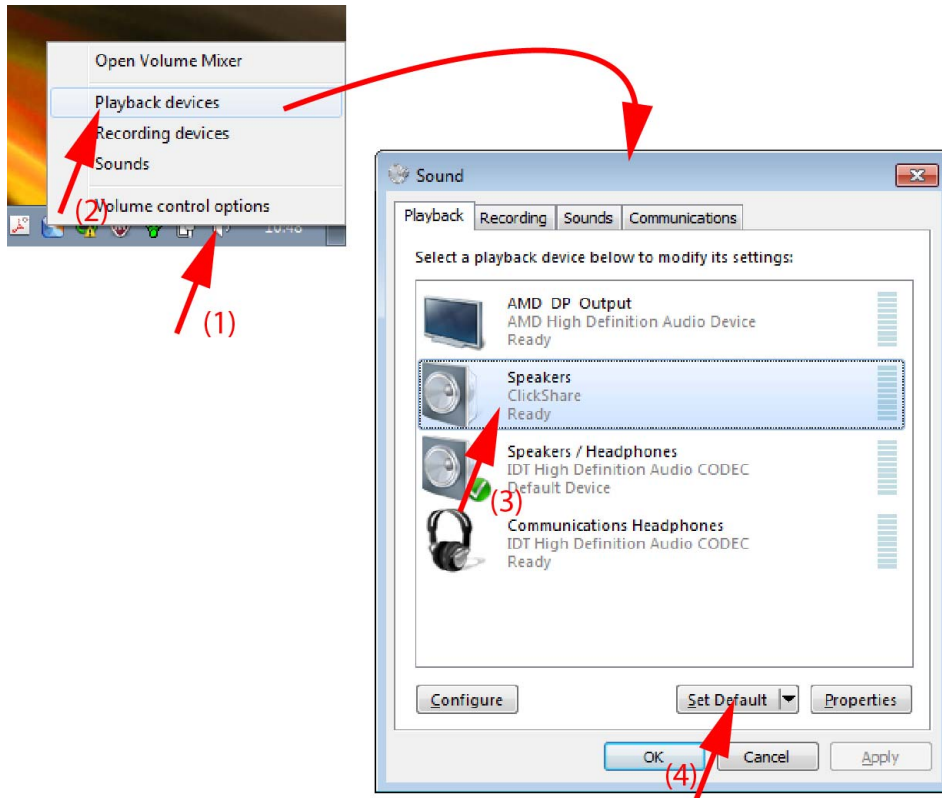

Image 3-23  
Speakers ClickShare, default

2. Click *Playback devices* (2).  
The *Sound* window opens on the *Playback* tab.
3. Select *Speakers ClickShare* (3) and click *Set default* (4).
4. Click **Apply** or **OK** to activate the new setting.

### Set ClickShare as default in Windows XP

1. Right click on the speaker icon in the system tray.

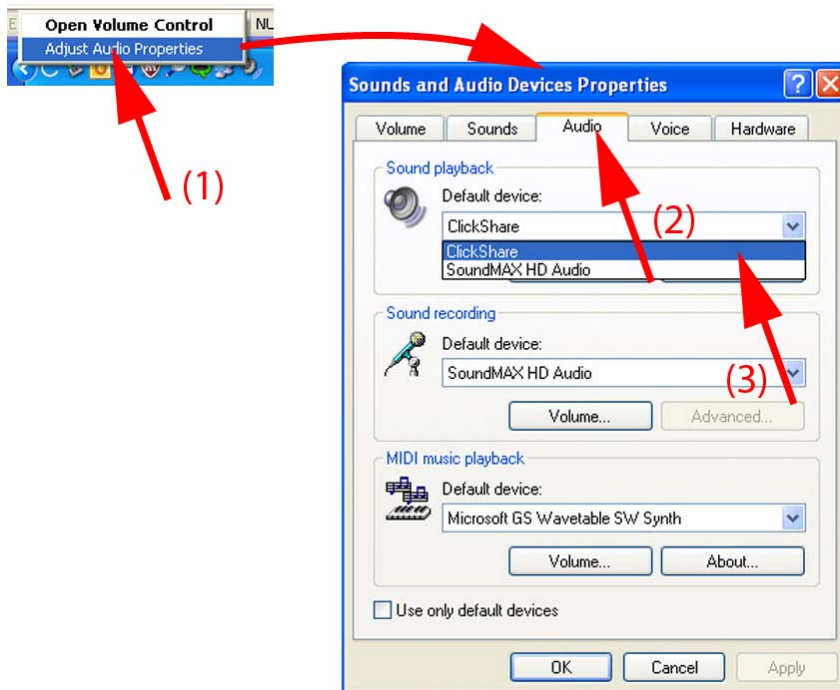

Image 3-24  
Speakers ClickShare, default

2. Click *Adjust Audio Properties* (1).  
The *Sound and Audio Devices Properties* window opens.
3. Select **Audio** tab (2).
4. Click on the drop down box in the *Sound playback* pane and select ClickShare (3)..
5. Click **Apply** or **OK** to activate the new setting.

### Set ClickShare as default on MAC

1. Click on the Apple logo on the menu bar (1) and select *System Preferences..* (2).

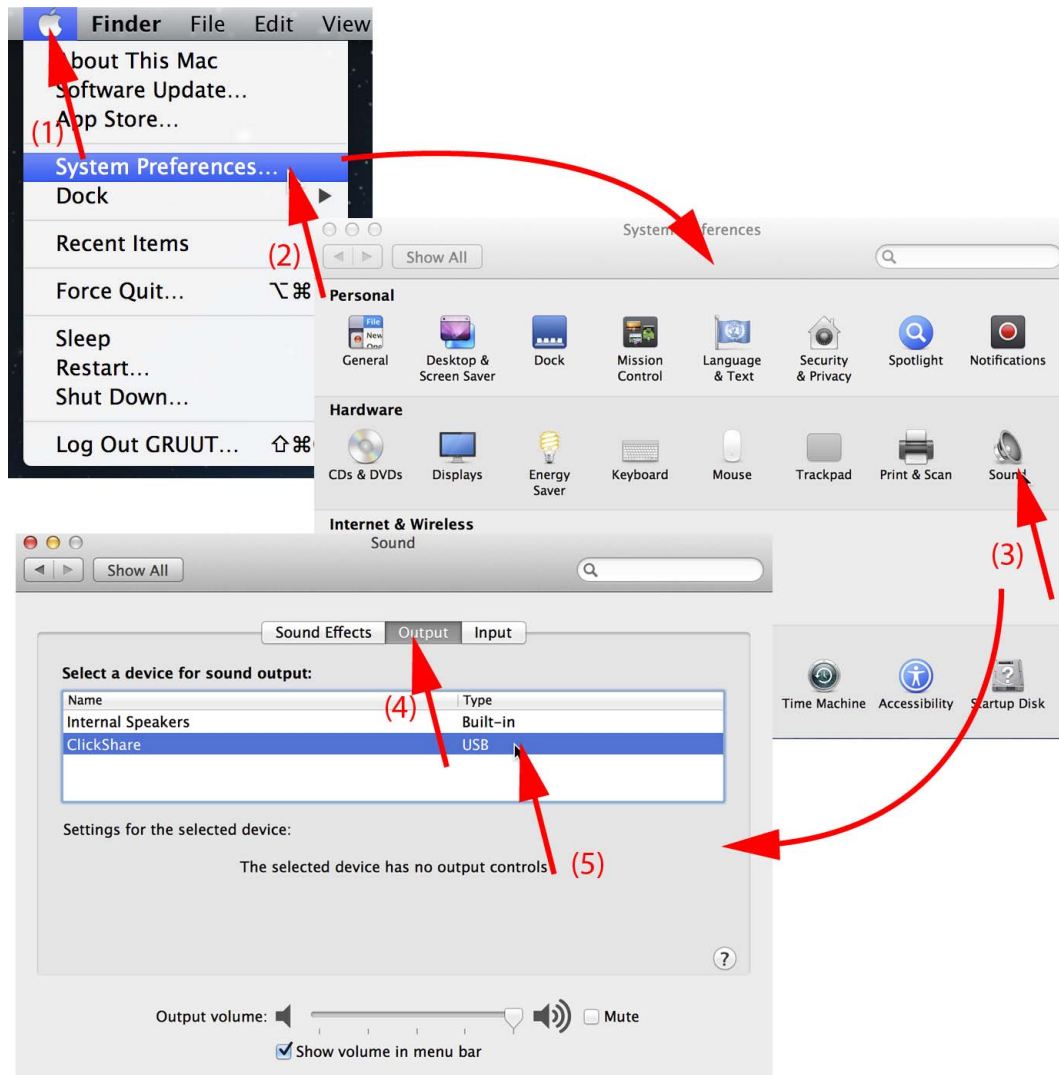

Image 3-25  
Speakers ClickShare, default

2. Click on the *Speaker* icon (3).  
The *Sound* window opens.
3. Select the *Output* tab (4) and activate ClickShare (5).

## 3.9 Pairing

### Pairing of the Buttons with the Base Unit

To be able to use a Button it should be assigned to the Base Unit you are using. This process is called pairing. By default, the four Buttons delivered with the ClickShare set are already paired to the specific Base Unit.

In case you buy additional Buttons or when a Button should be assigned to another Base Unit, the Button needs to be paired (again). When updating the Base Unit software, it is advised to also pair your Buttons with the Base Unit to update their software.



**A Button can only be paired to one Base Unit at a time.**

**The Button will always make connection to the Base Unit it was last paired to.**

### To pair a Button to the Base Unit

1. Insert the Button in the USB port at the front of the Base Unit you are using.

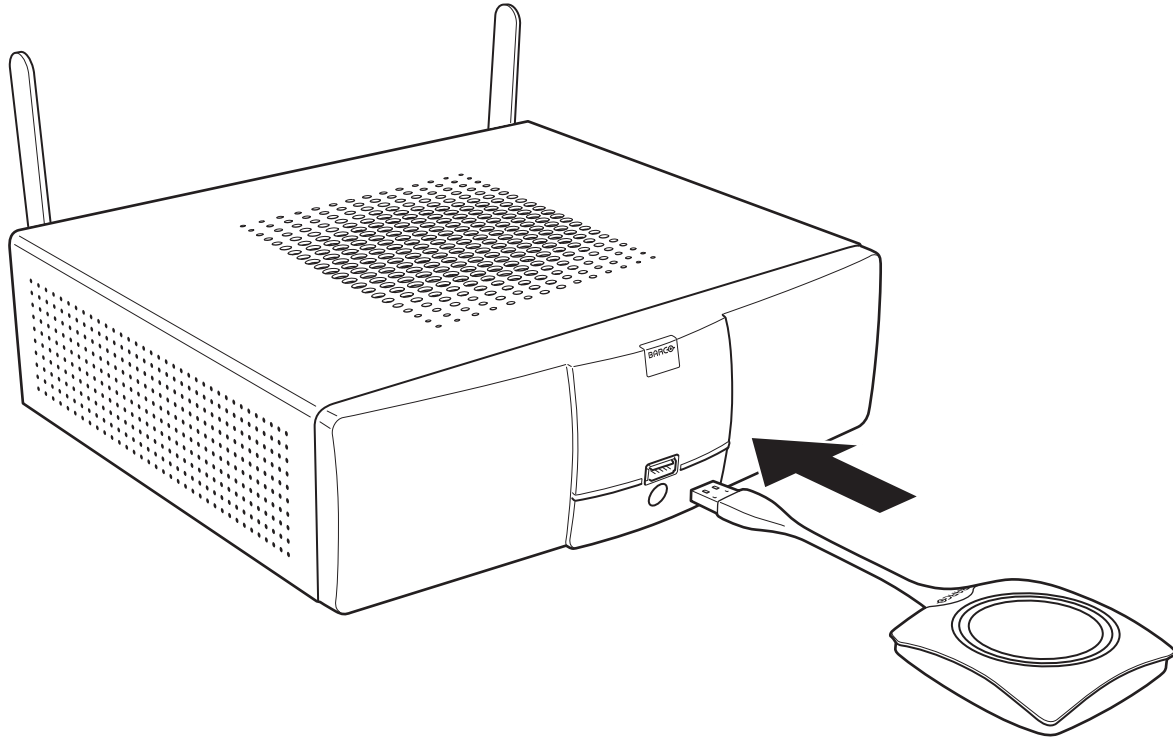

Image 3-26  
Inserting Button into the Base Unit

Both the LEDs of the Button and the LEDs of the Base Unit are blinking white. This means pairing is in progress.

The Base Unit automatically checks whether the software of the Button is up to date. If not, the Base Unit updates the Button software. This may take more time.

During the pairing and update process, a message is displayed on the screen: *"Pairing and updating Button. Busy pairing and updating"*

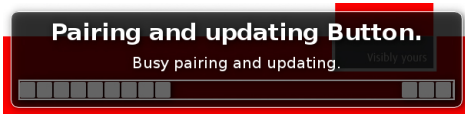

Image 3-27  
Pairing message

The result of the pairing process can be as follows:

- When the LEDs become static white, the Button is paired to the Base Unit, but no software update was needed. You can unplug the Button from the Base Unit.
- When the LEDs become static red, the Button is paired to the Base Unit and the software update has finished. You can unplug the Button from the Base Unit.



Image 3-28  
Pairing finished

2. Unplug the Button from the Base Unit.

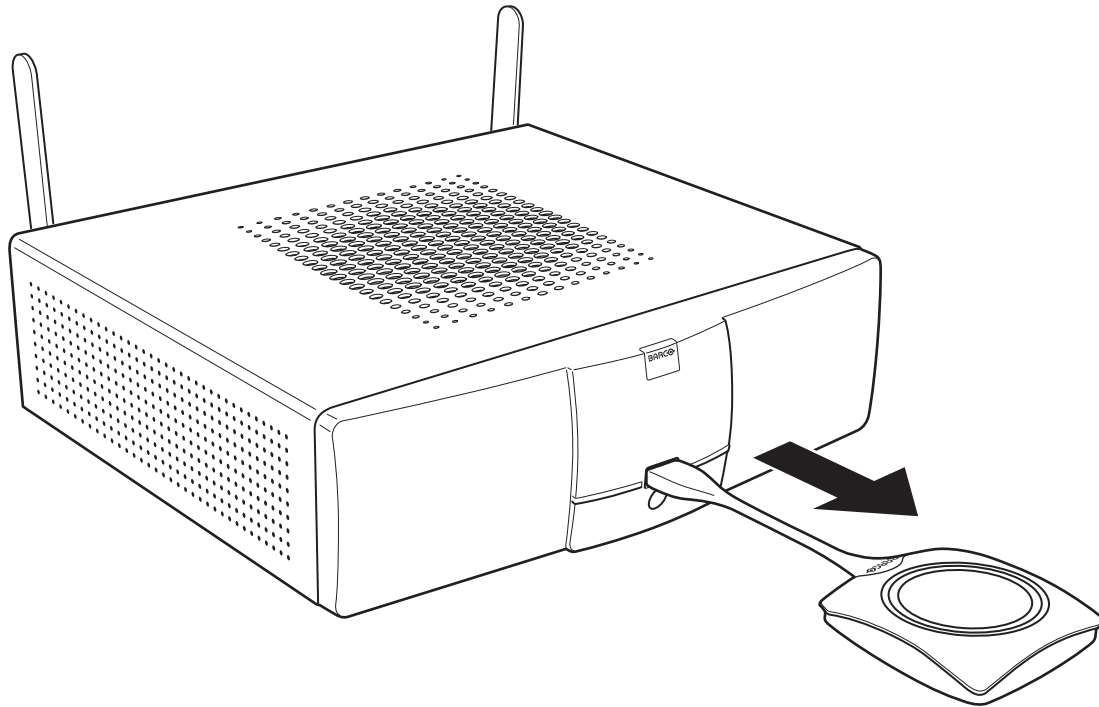

Image 3-29  
Unplug Button from Base Unit

The Button is now ready for use.



## 4. TROUBLESHOOTING

### 4.1 Basic Troubleshooting

#### Problem solving

In this chapter some problems that might occur while using ClickShare are listed. For each problem possible causes are given and a solution is proposed. If you cannot solve the problem yourself, please contact your local IT administrator.

Problem	Cause	Solution
Your screen is not shown on the display when pressing the Button.	You are the fifth person that wants to share his content to the display. Only four screens can appear simultaneously. A message appears on your computer. The ClickShare client software is not running.	Click and hold the Button to use the Show me full screen function of ClickShare. Refer to "Advanced Use", page 17. Go to the ClickShare drive and run the software.
Your screen is shown, but your audio is not playing on the meeting room audio system	Your audio signal on your PC is muted Audio on the Base Unit is disabled. Audio system of the meeting room is not switched on Audio cable is not connected Default speaker is not correctly set . Audio Functionality is not enabled in the Base Unit. Buttons are not re-paired after changing the audio setting on the web interface	Right click on the speaker icon and switch off the mute. You or an administrator should change the corresponding setting via the web interface. Switch on the audio system of the meeting room. Check audio connection between the Base Unit (audio out, green connector) and the audio system of the meeting room. With a Button inserted, set ClickShare speaker as your default speaker. Enable Audio Functionality in the Base Unit's web interface and re-pair the dongles. Re-pair the buttons.
Your content is removed from the display and the LEDs of your Button are blinking white.	Connection to the display has been lost.	ClickShare tries to restore the connection automatically. If this fails, the LEDs of the Button start blinking red. You should unplug the Button from your laptop and start a new.
Nothing is shown on the display at all.	The display is switched off. Wrong input is selected. The display cable is not connected (correctly). The display does not recognize or is not able to display the Base Unit output resolution. The Base Unit is in standby mode. The Base Unit is powered off. The Button's software is not compatible with that of the Base unit	Switch on the display. Select the correct input. (Re)insert the display cable to the display and the Base Unit. You or an administrator should change the corresponding setting via the web interface. Briefly push the standby button on the Base Unit or plug in a Button and run the ClickShare client software. Re-pair and update the software of the Button by inserting it in the front USB port of Base Unit.
Two laptops connected with the Base Unit in a dual display meeting room but only one shows an image	One of the displays is switched off One display cable is not connected	Switch on the display. (Re)insert the display cable to the display and the Base Unit.

#### 4. Troubleshooting

---

<b>Problem</b>	<b>Cause</b>	<b>Solution</b>
After inserting the Button into your laptop, you cannot find the ClickShare drive.	No automatic refresh of drives. Bad connection at USB port on laptop.	Refresh the view on your laptop. <ul style="list-style-type: none"><li>• Reconnect to the USB port.</li><li>• Try another USB port.</li><li>• Reboot your laptop.</li></ul>
	Windows tries to assign the ClickShare drive to an already reserved drive letter	Use Microsoft Windows Disk Management to assign it to a free drive letter.
Some programs of Windows are not shown on the display.	Use of overlays, 3D or hardware acceleration in the GPU.	<ul style="list-style-type: none"><li>• Disable overlays or hardware acceleration in the GPU.</li><li>• Disable AeroGlass in Windows 7</li></ul>



## 5. ENVIRONMENTAL INFORMATION

### 5.1 Disposal information

#### Disposal Information

Waste Electrical and Electronic Equipment



This symbol on the product indicates that, under the European Directive 2002/96/EC governing waste from electrical and electronic equipment, this product must not be disposed of with other municipal waste. Please dispose of your waste equipment by handing it over to a designated collection point for the recycling of waste electrical and electronic equipment. To prevent possible harm to the environment or human health from uncontrolled waste disposal, please separate these items from other types of waste and recycle them responsibly to promote the sustainable reuse of material resources.

For more information about recycling of this product, please contact your local city office or your municipal waste disposal service. For details, please visit the Barco website at: <http://www.barco.com/en/AboutBarco/weee>

#### Disposal of batteries in the product



This product contains batteries covered by the Directive 2006/66/EC which must be collected and disposed of separately from municipal waste.

If the battery contains more than the specified values of lead (Pb), mercury (Hg) or cadmium (Cd), these chemical symbols will appear below the crossed-out wheeled bin symbol.

By participating in separate collection of batteries, you will help to ensure proper disposal and to prevent potential negative effects on the environment and human health.

### 5.2 Rohs compliance

#### Turkey RoHS compliance



Türkiye Cumhuriyeti: EEE Yönetmeliğine Uygundur.

[Republic of Turkey: In conformity with the EEE Regulation]

#### 中国大陆 RoHS – Chinese Mainland RoHS

根据中国大陆《电子信息产品污染控制管理办法》(也称为中国大陆RoHS), 以下部分列出了Barco产品中可能包含的有毒和/或有害物质的名称和含量。中国大陆RoHS指令包含在中国信息产业部MCV标准:“电子信息产品中有毒物质的限量要求”中。

According to the “China Administration on Control of Pollution Caused by Electronic Information Products” (Also called RoHS of Chinese Mainland), the table below lists the names and contents of toxic and/or hazardous substances that Barco’s product may contain. The RoHS of Chinese Mainland is included in the MCV standard of the Ministry of Information Industry of China, in the section “Limit Requirements of toxic substances in Electronic Information Products”.

零件项目(名称)	有毒有害物质或元素					
Component Name	Hazardous Substances or Elements					
	铅 (Pb)	汞 (Hg)	镉 (Cd)	六价铬 (Cr6+)	多溴联苯 (PBB)	多溴二苯醚 (PBDE)
印制电路配件 Printed Circuit Assemblies	x	0	x	0	0	0
电(线)缆 Cables	x	0	x	0	0	0

## 5. Environmental information

底架 Chassis	x	0	x	0	0	0
电源供应器 Power Supply Unit	x	0	x	0	0	0
文件说明书 Paper Manuals	0	0	0	0	0	0

O: 表示该有毒有害物质在该部件所有均质材料中的含量均在 SJ/T 11363-2006 标准规定的限量要求以下。

O: Indicates that this toxic or hazardous substance contained in all of the homogeneous materials for this part is below the limit requirement in SJ/T11363-2006.

X: 表示该有毒有害物质至少在该部件的某一均质材料中的含量超出 SJ/T 11363-2006 标准规定的限量要求。

X: Indicates that this toxic or hazardous substance contained in at least one of the homogeneous materials used for this part is above the limit requirement in SJ/T11363 2006.

在中国大陆销售的相应电子信息产品 (EIP) 都必须遵照中国大陆《电子信息产品污染控制标识要求》标准贴上环保使用期限 (EFUP) 标签。Barco 产品所采用的 EFUP 标签 (请参阅实例, 徽标内部的编号用于制定产品) 基于中国大陆的《电子信息产品环保使用期限通则》标准。

All Electronic Information Products (EIP) that are sold within Chinese Mainland must comply with the "Electronic Information Products Pollution Control Labeling Standard" of Chinese Mainland, marked with the Environmental Friendly Use Period (EFUP) logo. The number inside the EFUP logo that Barco uses (please refer to the photo) is based on the "Standard of Electronic Information Products Environmental Friendly Use Period" of Chinese Mainland.



Image 5-1

## 5.3 Production address

### Factory

捷普科技(上海)有限公司

上海市田林路600号

邮编: 200233

---

# INDEX

## A

About 3, 5–6, 8–9  
  Base Unit 6  
  ClickShare 5  
  ClickShare product 5  
  The Button 8  
  Tray 9  
  User Guide 3  
About ClickShare 3  
About the Tray 9  
Address 32  
Advanced use 17  
Audio control 23

## B

Base Unit 6  
Basic information 3  
Basic Troubleshooting 29  
Basic use 14  
Button 8, 25  
  Pairing 25  
Button menu 20–21  
  Capture mode 20  
    Detailed 20  
    Fast 20  
  Shared desktop 21  
    Extended 21  
    Primary 21

## C

Capture mode 20  
  Detailed 20  
  Fast 20  
ClickShare App 9  
Client software 20

## E

Environmental information 31  
  Disposal information 31  
  Rohs compliance 31

## F

Full screen 17

## G

Getting started 14, 19

iOS device connection 19  
Getting Started 13

## I

Introduction 3–5  
  ClickShare 5  
  Fonts 4  
  symbols 4  
  User Guide 3  
iOS device 19

## L

Led ring 8  
LED strips 6

## P

Pairing Buttons 25  
Power off 13  
Power on 13  
Problem solving 29  
Production 32

## R

Regional versions 3

## S

Shared desktop 21  
  Extended 21  
  Primary 21  
Standby button 6  
Standby mode 13  
Symbols 4

## T

Troubleshooting 29

## U

User Interface 20

## V

Versions 3